



型号

MLV40-LL-IR/47/115

玻璃光纤光电开关
带 2 m 固定电缆

特性

- 坚固的铝制外壳
- 光纤适配器带快速锁紧装置
- 所需安装空间小
- 作为附件，广泛的管线产品可供选择

外形尺寸

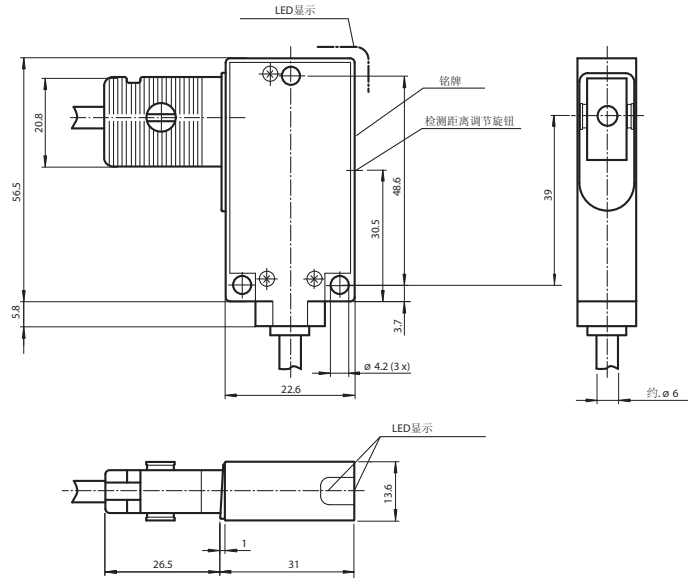

电气连接

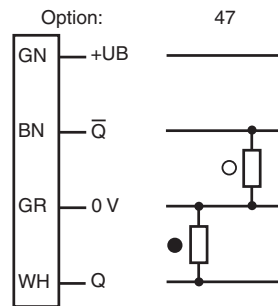

- = 亮通
- = 暗通

Release date: 2007-11-27 Date of issue: 2010-11-26 419653_cn.xml

附件参数可从网上下载。

技术参数

一般说明

检测距离	取决于所选用的光纤，见光纤选型表
光源类型	红外光 LED
认证	CE, cULus
可调范围	取决于所选用的光纤
光源特性	红外光，调制光
极限环境光强	50000 Lux

指示灯 / 动作说明

功能显示	黄色 LED: 不稳定时闪烁
调节元件	灵敏度调节旋钮

电气特性

工作电压	U_B	10 ... 30 V DC
纹波		10 %
空载电流	I_0	40 mA

输出

开关类型	亮 / 暗通可选
信号输出	2 路独立 PNP, 短路保护, 反极性保护
负载电压	最大 30 V DC
负载电流	最大 200 mA
开关频率	f 100 Hz
电流损耗	≤ 40 mA
响应时间	5 ms

符合标准

标准	IEC / EN 60947-5-2
----	--------------------

环境温度

工作温度	-20 ... 60 °C (253 ... 333 K)
储藏温度	-20 ... 75 °C (253 ... 348 K)

机械特性

LWL-Adapter	04
防护等级	IP65
连接	2 m 固定电缆
材料	
外壳	铝
光学透镜	玻璃
重量	100 g

光纤选型表

	光纤型号	检测距离 mm			Figure
		MLV40-LL-IR	MLV40-LL-RT	SU14-LL	
带 PVC 外套 的单路玻璃 光纤	LCE04-1,1,0,5-WC3	100	50	100	1
	LCE04-1,1,1,5-WC3	110	60	80	1
	LCE04-1,6,0,5-WC3	280	80	160	2
	LCE04-1,6-1,0-WC3	200	60	120	2
	LCE04-1,6-1,0-Z1	280	80	160	3
	LCE04-1,6-1,0-G	280	80	160	4
带 PVC 外套 的反射型玻 璃光纤	LCR04-1,1,0,5-WC3	50	25	40	5
	LCR04-1,6-1,0-WC3	100	50	80	6
	LCR04-1,6,0,5-WC2	50	20	40	7
	LCR04-1,6,0,5-Z1	80	40	80	8
	LCR04-1,6-1,0-Z1	100	50	80	8
	LCR04-1,6-1,0-G	100	50	80	9
带金属硅外 套的单路玻 璃光纤	LLE04-1,6-1,0-G	280	40	160	10
	LLE04-1,6-1,0-Z1	280	40	160	11
	LLE04-1,6-1,0-WC3	280	35	160	12
	LLE04-1,6-1,0-WC15	250	35	140	13

Release date: 2007-11-27 Date of issue: 2010-11-26 419653_cn.xml

带金属硅外套的反射型玻璃光纤	LLR04-1,6-0,5-G	90	40	80	14
	LLR04-1,6-1,0-G	100	50	80	14
	LLR04-1,6-0,5-QW1x4	80	35	60	18
	LLR04-1,6-1,0-QW1x4	60	40	40	18
	LLR04-1,6-0,5-WC3	80	35	60	15
	LLR04-1,6-1,0-WC3	100	50	80	15
	LLR04-1,9-1,0-WC5	100	50	70	16
	LLR04-1,6-1,0-Z1	110	50	80	17
带金属外套的单路玻璃光纤	LME04-0,8-0,5-Z1	80	40	60	19
	LME04-0,8-1,0-Z1	60	30	40	19
	LME04-1,6-0,5-Z1	160	80	120	20
	LME04-1,9-0,5-Z1	200	100	150	20
	LME04-1,6-1,0-WC3	120	60	80	23
	LME04-0,8-0,5-WC4	70	35	45	21
	LME04-1,6-1,5-WC4	120	60	80	22
带金属外套的反射型玻璃光纤	LMR04-0,5-0,5-WC4	6	5	5	24
	LMR04-0,5-0,5-Z0	7	6	5	26
	LMR04-0,5-0,5-Z1	7	6	5	25
	LMR04-1,6-0,5-Z1	80	35	60	27
	LMR04-1,9-0,5-Z1	90	40	70	28
	LMR04-0,6-0,5-QW0,25/2	5	3	4	29

其他长度和末端可按要求提供

Adapter

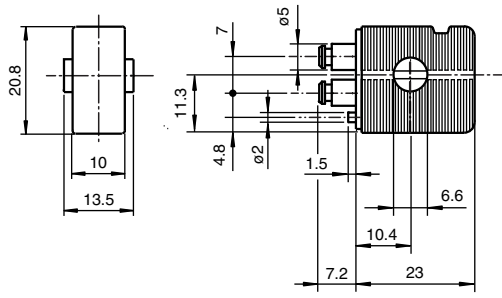

Thru-beam

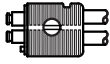

Reflex



Fig. 1

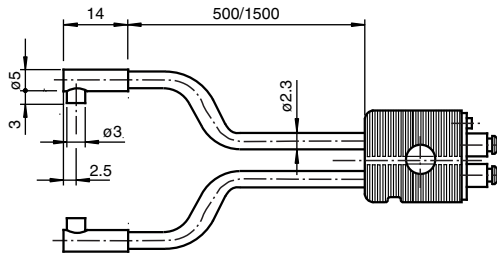

Fig. 2

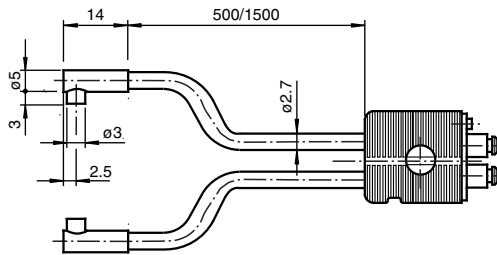

Fig. 3

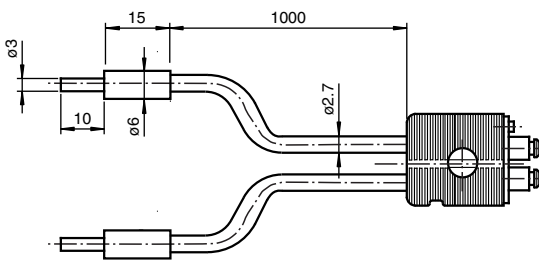

Fig. 4

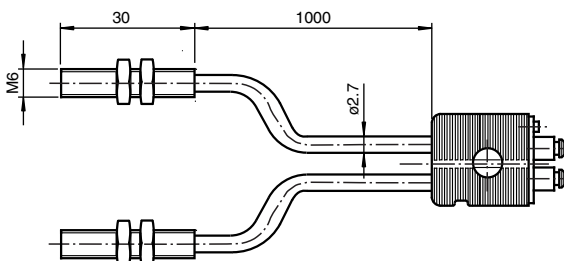

Fig. 5

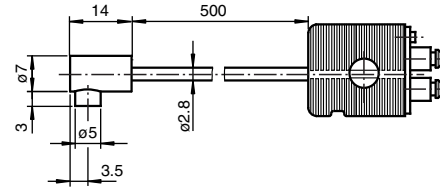

Fig. 6

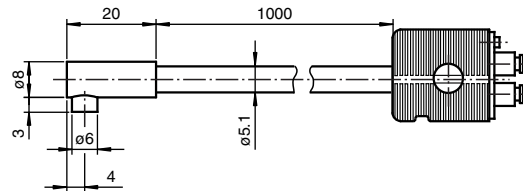

Fig. 7

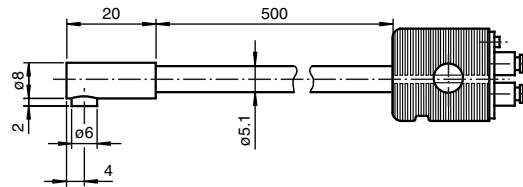

Fig. 8

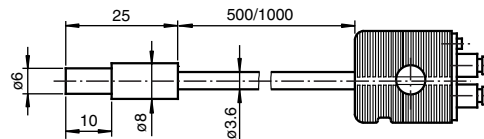
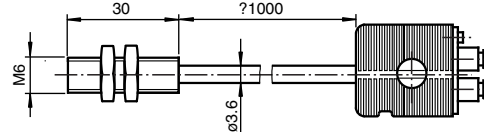

Fig. 9



Release date: 2007-11-27 Date of issue: 2010-11-26 419653_cn.xml

Fig. 10

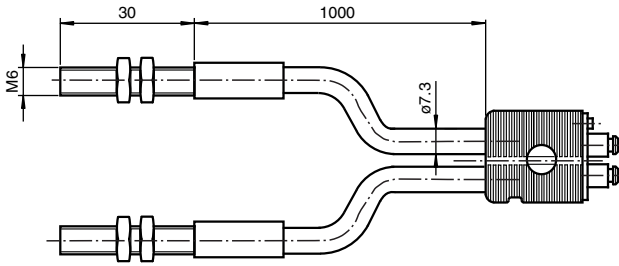

Fig. 11

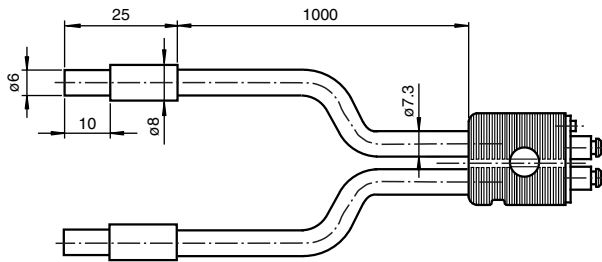

Fig. 12

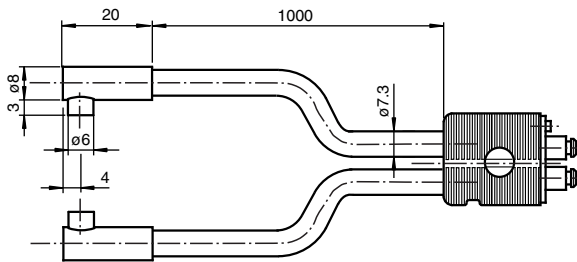

Fig. 13

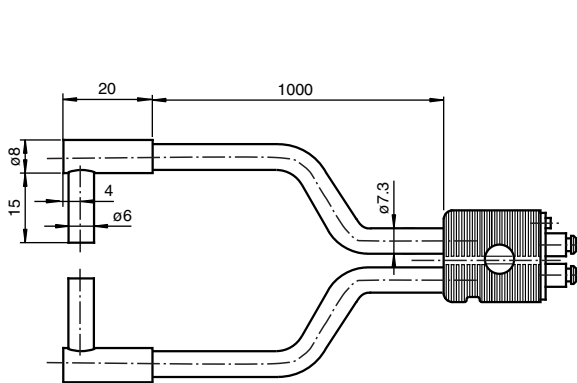

Fig. 14

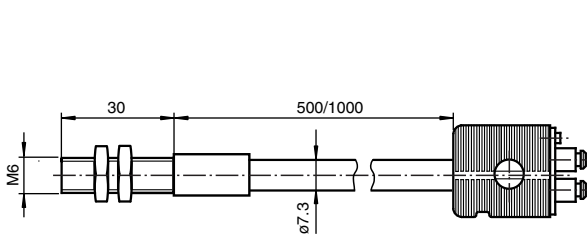

Fig. 15

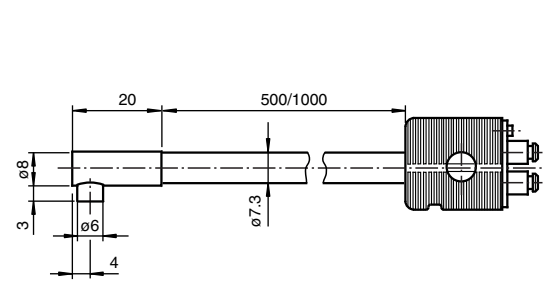

Fig. 16

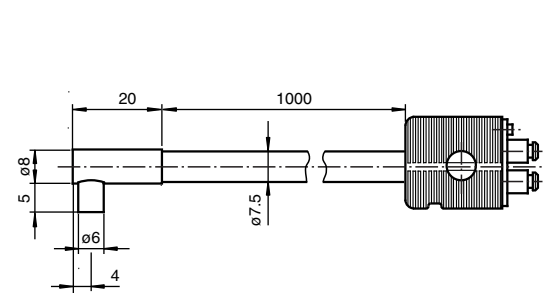

Fig. 17

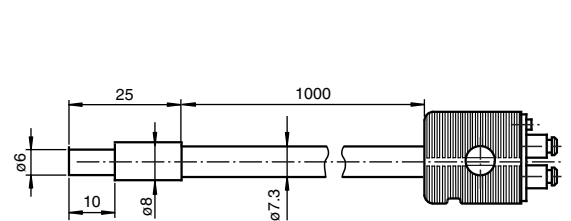

Fig. 18

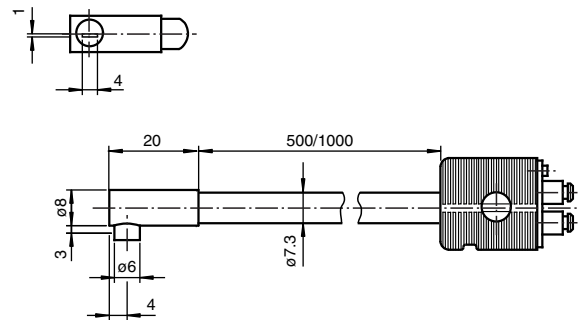
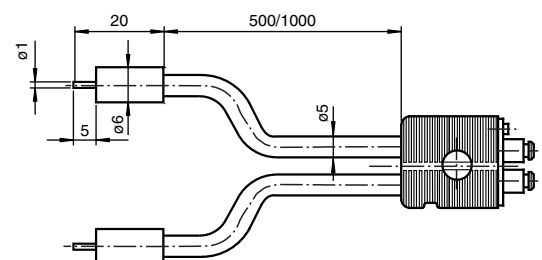

Fig. 19



Release date: 2007-11-27 Date of issue: 2010-11-26 419653_cn.xml

Fig. 20

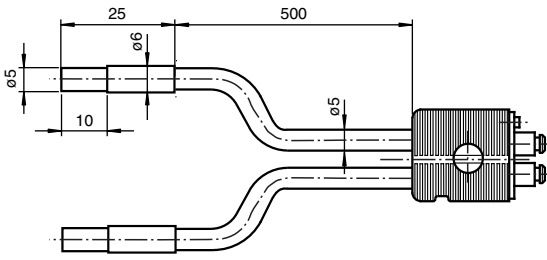

Fig. 25

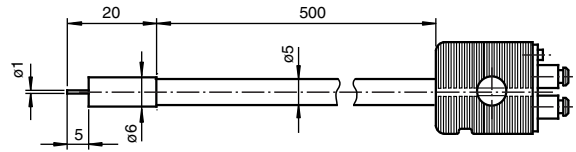

Fig. 21

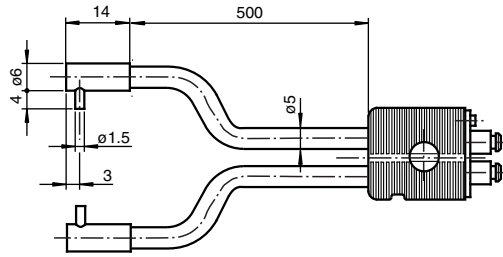

Fig. 26

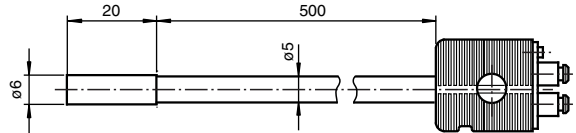

Fig. 22

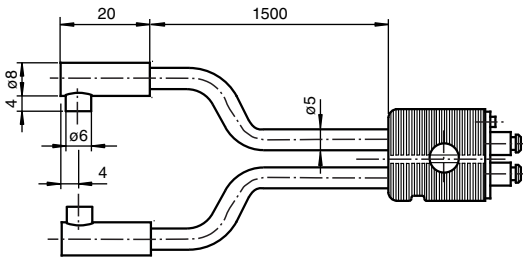

Fig. 27

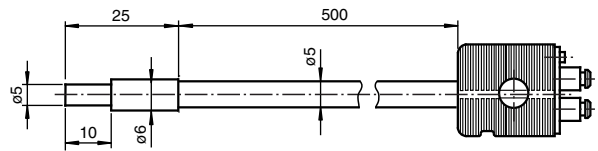

Fig. 23

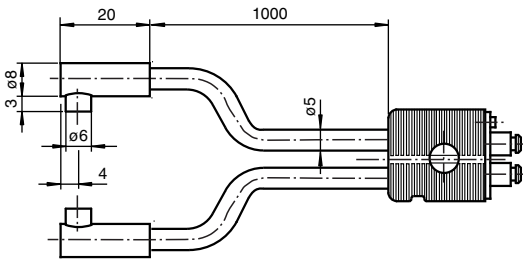

Fig. 28

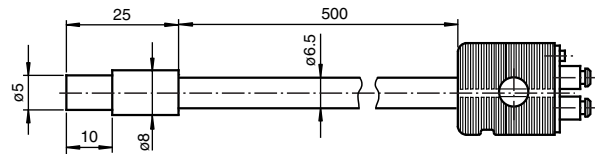

Fig. 24

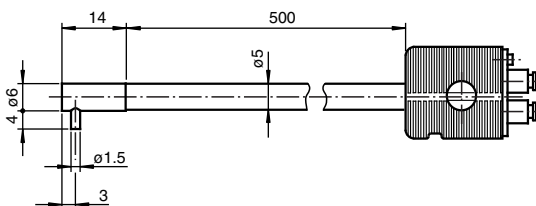
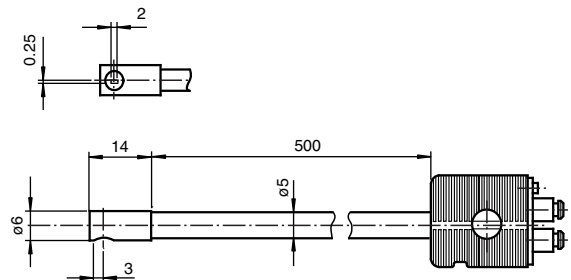

Fig. 29



Release date: 2007-11-27 Date of issue: 2010-11-26 419653_cn.xml