

Accessories - Reflectors

ORR 80

Retro-reflector

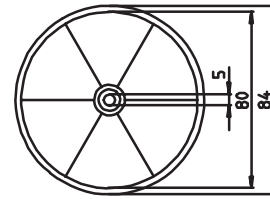

ORR 60

Retro-reflector

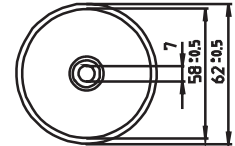

ORR 20

Retro-reflector

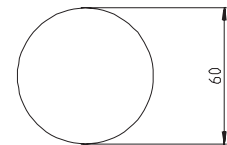
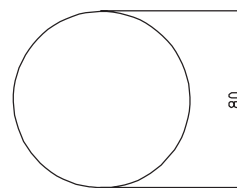

ORE 80 / ORE 60

Double sided self adhesive pad for rapid fixing of retro reflectors type ORR 80/60.

- Base material: Closed cell polyethylene foam
- Adhesive: Ageing resistant acrylic adhesive
- Colour: White
- Covering: Smooth backing paper
- Thickness: 1 mm (without backing paper)
- Tensile strength: 30 N/25 mm
- Rupt. elongat.: 180 %
- Temperature stability: 80 °C (short term), 60 °C (contin.)

ORR 100

Retro-reflector
Reflector surface 100x100
Lateral mounting holes

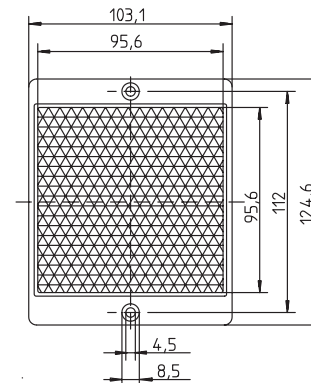

ORR 50

Retro-reflector
Reflector surface 50x50
Lateral mounting holes

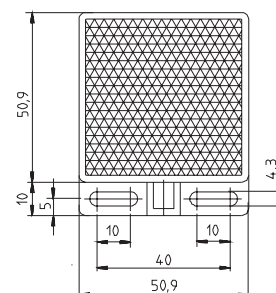

OFR 70

Foil-reflector
Reflector surface 70x70

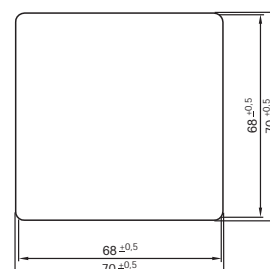

Date of issue 13.01.98