

MLV40-LL-RT/47/115

Cellule pour fibres optiques en verre

MLV40-LL-RT/47/115

câble 2 m



- ◆ Boîtier robuste en aluminium
- ◆ Adaptateur pour fibre optique à raccordement instantané
- ◆ Encombrement moindre
- ◆ Gamme complète de fibres optiques en accessoires

Caractéristiques générales

Domaine de détection	dépend de la fibre optique utilisée voir "Tableau de sélection des fibres optiques"
Emetteur de lumière	LED, lumière rouge
Agréments	CE, cULus
Domaine de réglage	dépend de la fibre optique utilisée
Type de lumière	rouge, lumière modulée
Limite de la lumière ambiante	50000 Lux

Éléments de visualisation/réglage

Visual. état de commutation	LED jaune : clignote si la réserve de fonction est insuffisante
Critères de choix	Réglage de la sensibilité

Caractéristiques électriques

Tension d'emploi	10 ... 30 V C.C.
Ondulation	10 %
Consommation à vide I_0	40 mA

Sortie

Mode de commutation	commutation "clair/foncé"
Sortie signal	2 PNP, antivalentes, protégées contre les courts-circuits/inversion de polarité
Tension de commutation	max. 30 V C.C.
Courant de commutation	max. 200 mA
Fréquence de commutation f	100 Hz
Consommation en courant	≤ 40 mA
Temps d'action	5 ms

Conformité aux normes

Normes	EN 60947-5-2
--------	--------------

Environnement

Température ambiante	-20 ... 60 °C (253 ... 333 K)
Température de stockage	-20 ... 75 °C (253 ... 348 K)

Caractéristiques mécaniques

adaptateur fibre optique (LWL)	04
Protection	IP65
Raccordement	câble 2 m
Matériau	
Boîtier	Aluminium
Sortie optique	verre
Masse	100 g

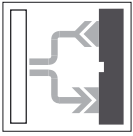

MLV40-LL-RT/47/115

Date de publication: 2005-12-06 09:42 Date d'édition: 2006-03-23 T1567_FRA.xml

Dimensions

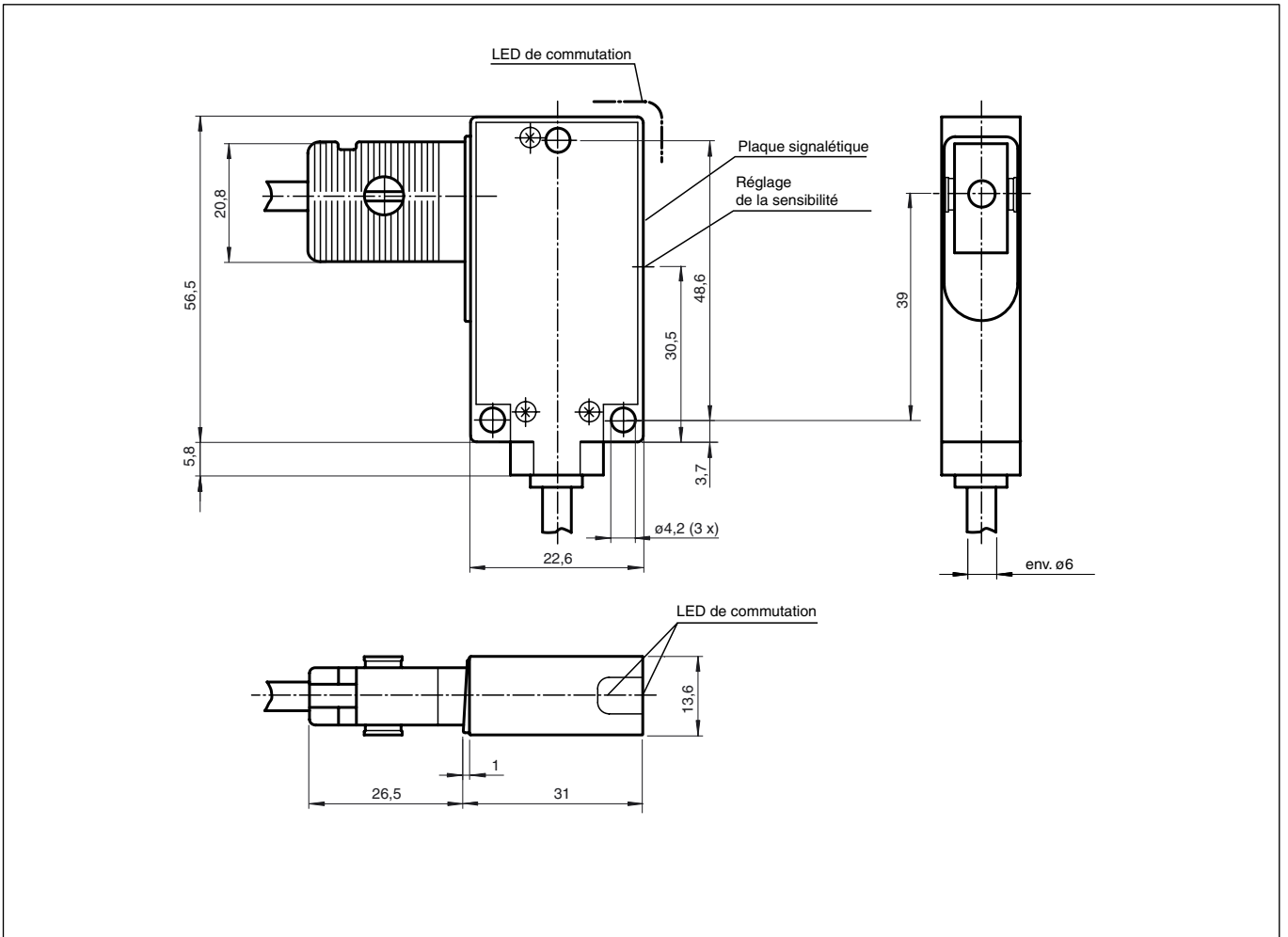

Raccordement électrique

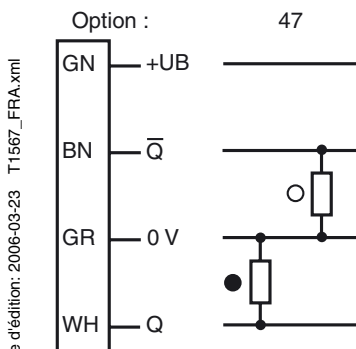

○ = commutation "claire", ● = commutation "forcé"

Date de publication: 2005-12-06 09:42 Date d'édition: 2006-03-23 T1567_FRA.xml

Sous réserve de modifications en raison d'améliorations techniques.

Copyright Pepperl+Fuchs, Printed in Germany

Pepperl+Fuchs SARL • FRANCE • 12 av. des Tropiques • 91955 Courtaboeuf Cedex • tél. 01 60 92 13 13 • fax 01 60 92 13 25
 Pepperl+Fuchs N.V./S.A. • BELGIQUE • Metropoolstraat 11 • 2900 Schoten • tél. 03/644.25.00 • fax 03/644.24.41

Tableau de sélection des fibres optiques

	Référence	Domaine de la portée (mm) avec			Figure
		MLV40-LL-IR	MLV40-LL-RT	SU14-LL	
Fibres optiques en verre avec gaine PVC (barrage)	LCE04-1,1-0,5-WC3	100	50	100	1
	LCE04-1,1-1,5-WC3	110	60	80	1
	LCE04-1,6-0,5-WC3	280	80	160	2
	LCE04-1,6-1,0-WC3	200	60	120	2
	LCE04-1,6-1,0-Z1	280	80	160	3
	LCE04-1,6-1,0-G	280	80	160	4
Fibres optiques en verre avec gaine PVC (détection directe)	LCR04-1,1-0,5-WC3	50	25	40	5
	LCR04-1,6-1,0-WC3	100	50	80	6
	LCR04-1,6-0,5-WC2	50	20	40	7
	LCR04-1,6-0,5-Z1	80	40	80	8
	LCR04-1,6-1,0-Z1	100	50	80	8
	LCR04-1,6-1,0-G	100	50	80	9
Fibres optiques en verre avec gaine silicone recouverte de métal (barrage)	LLE04-1,6-1,0-G	280	40	160	10
	LLE04-1,6-1,0-Z1	280	40	160	11
	LLE04-1,6-1,0-WC3	280	35	160	12
	LLE04-1,6-1,0-WC15	250	35	140	13
Fibres optiques en verre avec gaine silicone recouverte de métal (détection directe)	LLR04-1,6-0,5-G	90	40	80	14
	LLR04-1,6-1,0-G	100	50	80	14
	LLR04-1,6-0,5-QW1x4	80	35	60	18
	LLR04-1,6-1,0-QW1x4	60	40	40	18
	LLR04-1,6-0,5-WC3	80	35	60	15
	LLR04-1,6-1,0-WC3	100	50	80	15
	LLR04-1,9-1,0-WC5	100	50	70	16
	LLR04-1,6-1,0-Z1	110	50	80	17
Fibres optiques en verre avec gaine métallique (barrage)	LME04-0,8-0,5-Z1	80	40	60	19
	LME04-0,8-1,0-Z1	60	30	40	19
	LME04-1,6-0,5-Z1	160	80	120	20
	LME04-1,9-0,5-Z1	200	100	150	20
	LME04-1,6-1,0-WC3	120	60	80	23
	LME04-0,8-0,5-WC4	70	35	45	21
	LME04-1,6-1,5-WC4	120	60	80	22
Fibres optiques en verre avec gaine métallique (détection directe)	LMR04-0,5-0,5-WC4	6	5	5	24
	LMR04-0,5-0,5-Z0	7	6	5	26
	LMR04-0,5-0,5-Z1	7	6	5	25
	LMR04-1,6-0,5-Z1	80	35	60	27
	LMR04-1,9-0,5-Z1	90	40	70	28
	LMR04-0,6-0,5-QW0,25/2	5	3	4	29

Autres longueurs et têtes sur demande

Date de publication: 2005-12-06 09:42 Date d'édition: 2006-03-23 T1567_FRA.xml

MLV40-LL-RT/47/115

Adaptateur

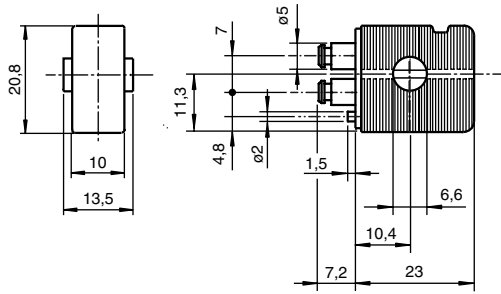

Mode barrage



Mode reflex



Fig. 1

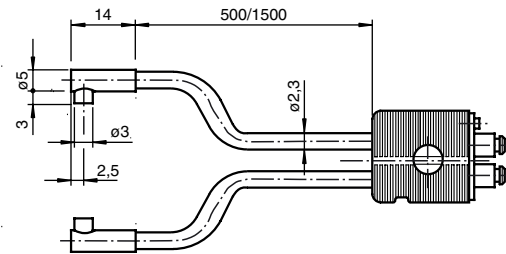

Fig. 2

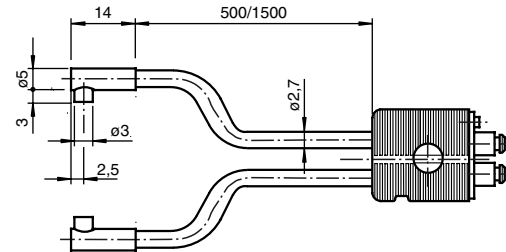

Fig. 3

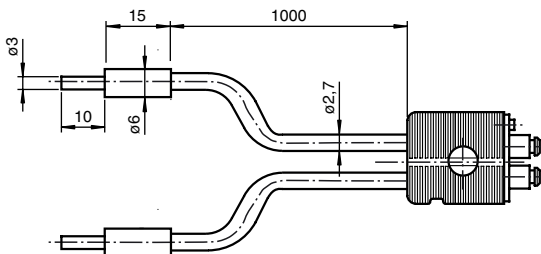

Fig. 4

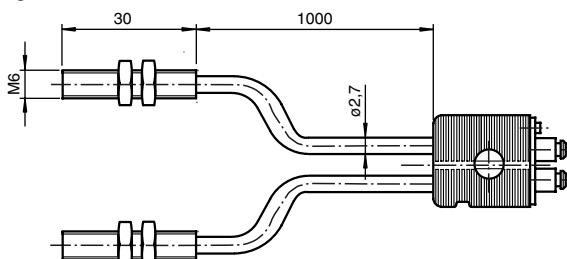

Fig. 5

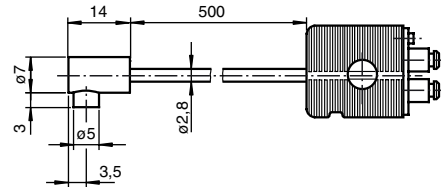

Fig. 6

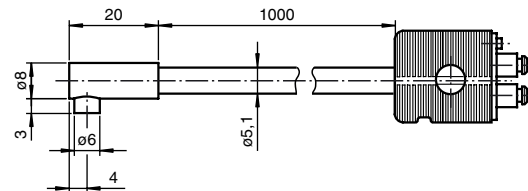

Fig. 7

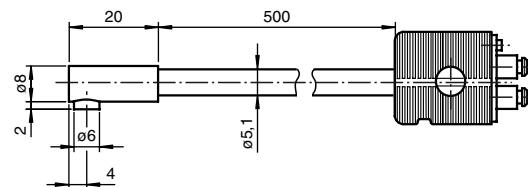

Fig. 8

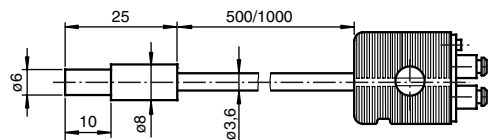
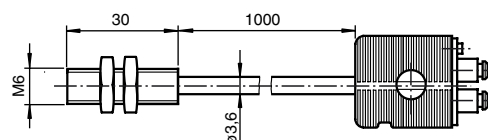

Fig. 9



Sous réserve de modifications en raison d'améliorations techniques.

Copyright Pepperl+Fuchs, Printed in Germany

MLV40-LL-RT/47/115

Fig. 10

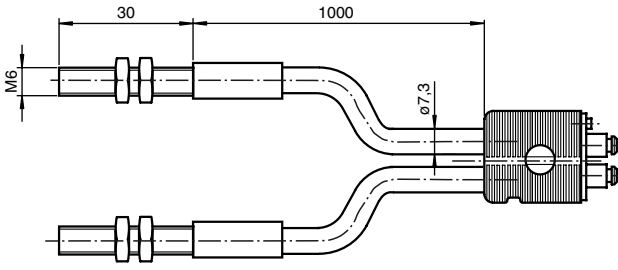

Fig. 11

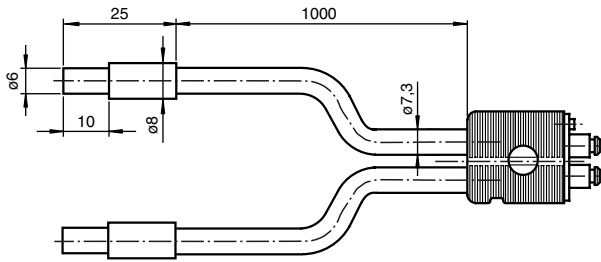

Fig. 12

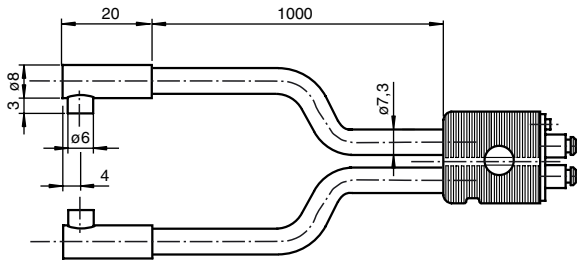

Fig. 13

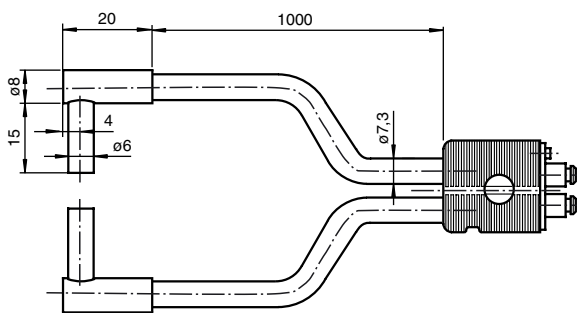

Fig. 14

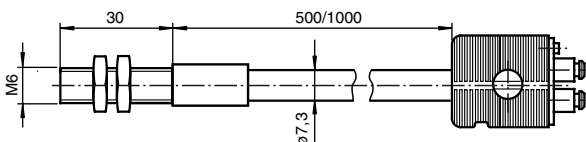

Fig. 15

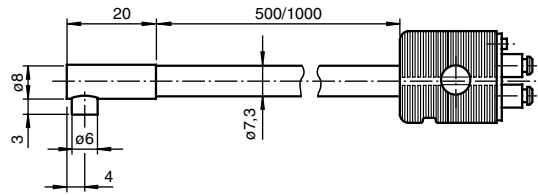

Fig. 16

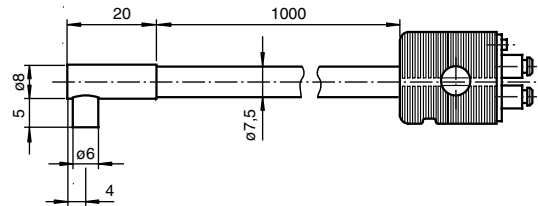

Fig. 17

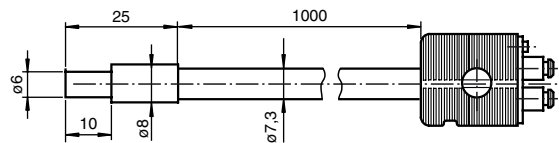

Fig. 18

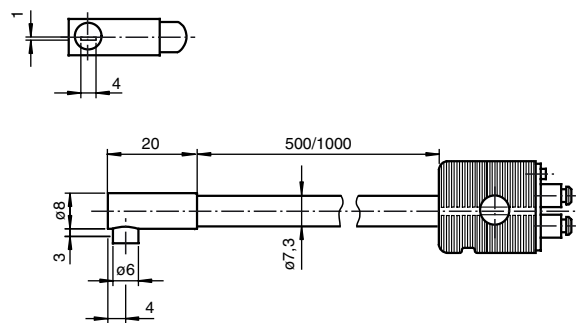
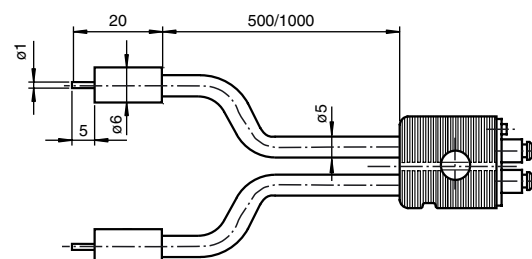

Fig. 19



Date de publication: 2005-12-06 09:42 Date d'édition: 2006-03-23 T1567_FRA.xml

Fig. 20

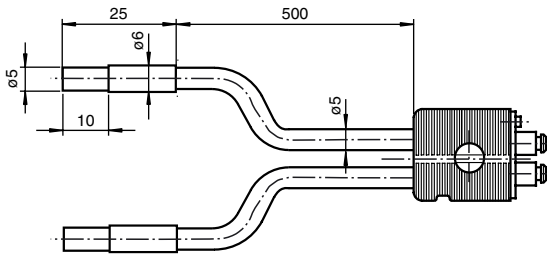

Fig. 25

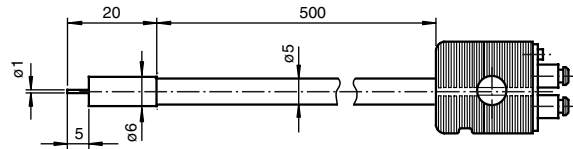

Fig. 21

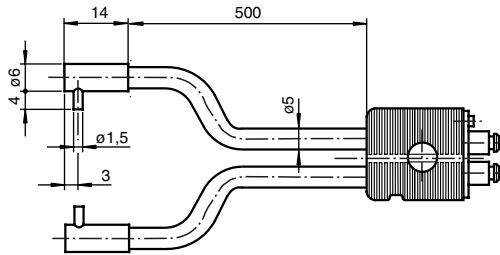

Fig. 26

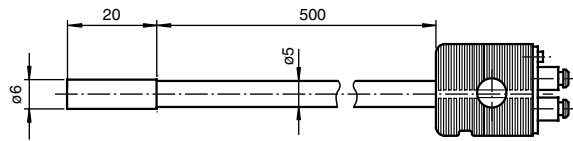

Fig. 22

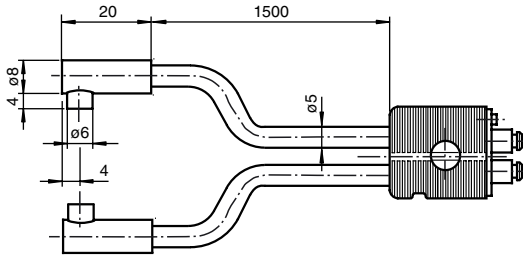

Fig. 27

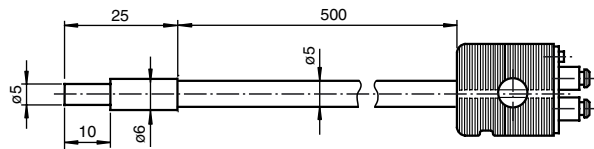

Fig. 23

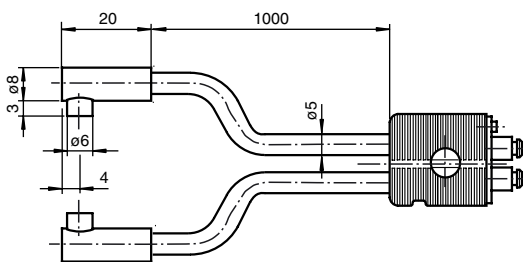

Fig. 28

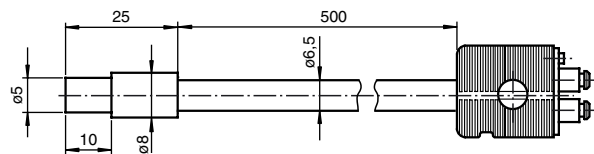

Fig. 24

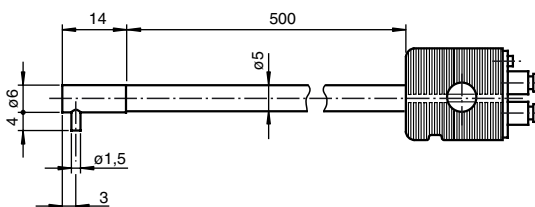

Fig. 29

