

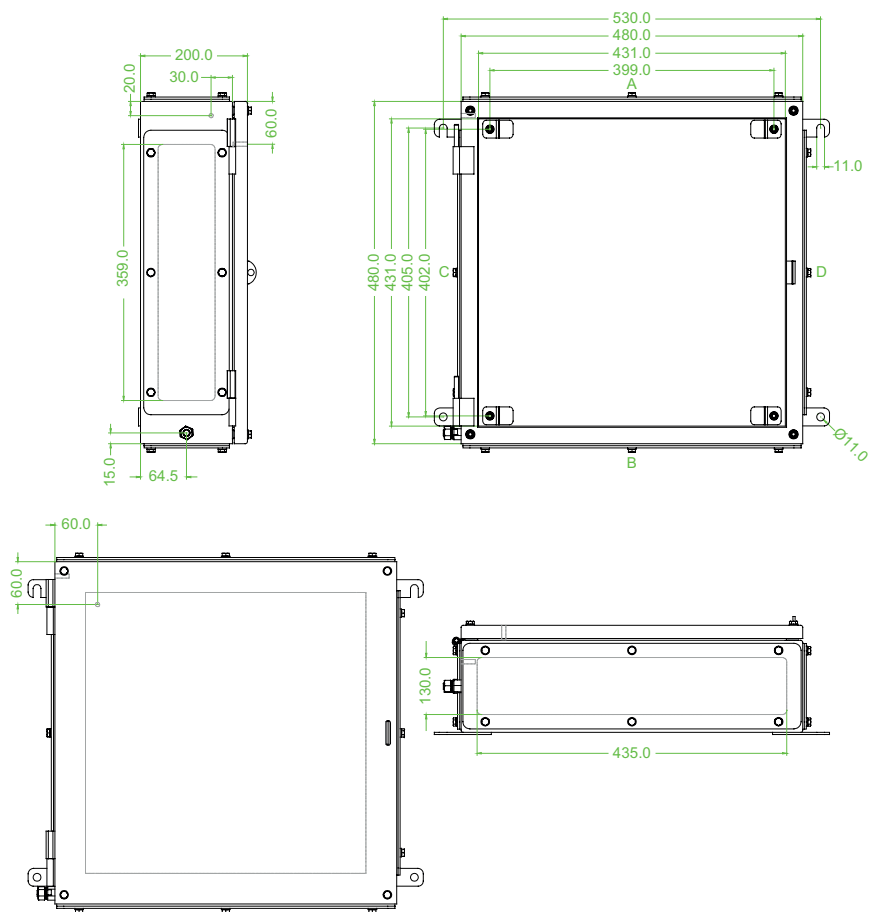

### Features

- 480 mm x 480 mm x 200 mm
- 316L Stainless Steel
- Installation in Zone 0, Zone 1, Zone 2, Zone 21 and Zone 22
- Straight Edge Sealing
- 2 Gland Plates
- M10 internal/external brass earth stud
- Ex ia certified

### Dimensions (mm)



4 gland plate drawing and image shown.

### Technical data

#### Conformity

Protection degree EN 60529

#### Ambient conditions

Ambient temperature -40 ... 85 °C (-40 ... 185 °F)

#### Mechanical specifications

Height 480 mm

Width 480 mm

Depth 200 mm

Enclosure cover fully detachable  
exposed hinges

Cover fixing M6 stainless steel hexagon head slotted screws

Safety Padlockable hasp

Protection degree IP66/67

Cable entry thru-holes direct through body  
or via gland plate

Gland plate on face(s) A & B

Defined entry area

Faces A and B 130 mm x 435 mm

Faces C and D 130 mm x 359 mm

#### Terminal assembly

Rail orientation vertical or horizontal

Number of rails vertical: 4  
horizontal: 4

Usable length per rail vertical: 390 mm  
horizontal: 387 mm

#### Material

Enclosure 1.5 mm 316L, (1.4404) stainless steel

Gland plate 3 mm 316L, (1.4404) stainless steel

Finish	electropolished
Seal	one piece closed cell neoprene
Mass	approx. 13 kg
Mounting	2x thru-holes Ø11 mm 2x hook feet with 11 mm wide slots
Grounding	M10 internal/external brass grounding bolt M6 internal stainless steel grounding bolt welded to lid M6 internal stainless steel grounding bolt welded to body
<b>Data for application in connection with Ex-areas</b>	
EC-Type Examination Certificate	SIRA 99 ATEX 3199
Group, category, type of protection, temperature class	⊕ II 1 G, ⊕ II 2 D Ex ia IIC T6 Ga, Ex tb IIIC T80 °C Db ( ta ... +40°C ) Ex ia IIC T5 Ga, Ex tb IIIC T95 °C Db ( ta ... +55°C ) Ex ia IIC T4 Ga, Ex tb IIIC T130 °C Db ( ta ... +85°C )
Maximum power dissipation	30 W
<b>International approvals</b>	
IECEX approval	IECEX SIR 06.0074
GOST-R approval	GOST-R B01008
<b>General information</b>	
Supplementary information	EC-Type Examination Certificate, Statement of Conformity, Declaration of Conformity, Attestation of Conformity and instructions have to be observed where applicable. For information see <a href="http://www.pepperl-fuchs.com">www.pepperl-fuchs.com</a> .
<b>Accessories</b>	
Optional accessories	Equipment mounting plate, same material as box M10 internal/external stainless steel grounding bolt

### Guide to Entry Capacity

Gland size mm	20	25	32
Side A + B	43	30	17
Side C + D	38	24	14