

Features

- 260 mm x 260 mm x 150 mm
- CR4 Mild Steel
- Installation in Zone 0, Zone 1, Zone 2, Zone 21 and Zone 22
- Straight Edge Sealing
- No Gland Plate
- M10 internal/external brass earth stud
- Ex ia certified

Dimensions (mm)

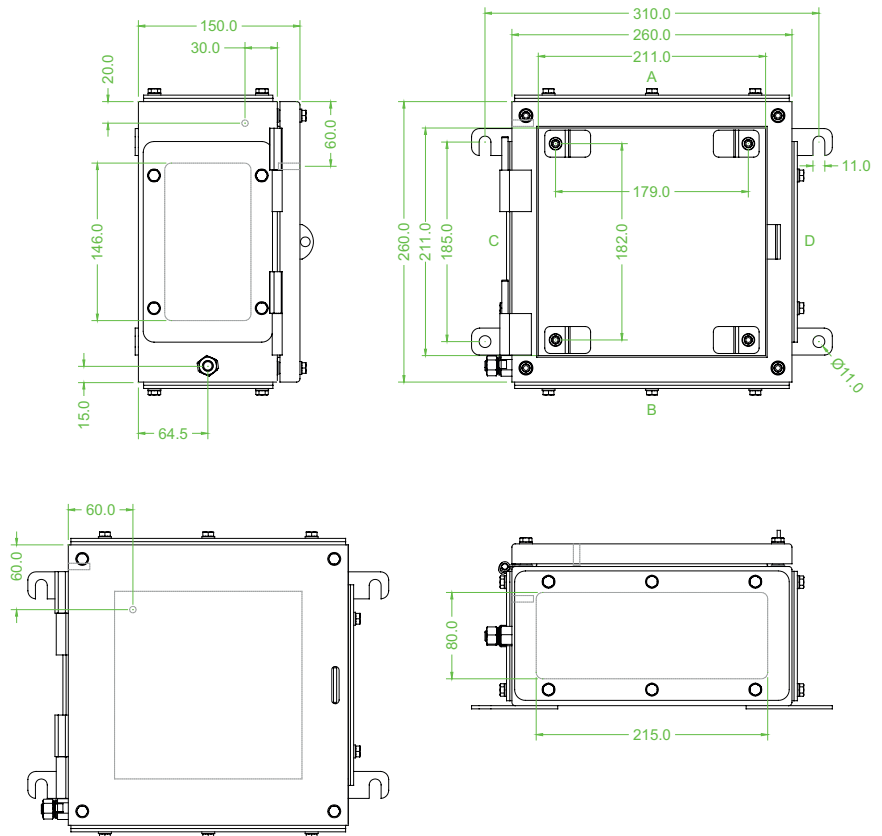

4 gland plate drawing and image shown.

Technical data

Conformity	
Protection degree	EN 60529
Ambient conditions	
Ambient temperature	-40 ... 85 °C (-40 ... 185 °F)
Mechanical specifications	
Height	260 mm
Width	260 mm
Depth	150 mm
Enclosure cover	fully detachable exposed hinges
Cover fixing	M6 stainless steel hexagon head slotted screws
Safety	Padlockable hasp
Protection degree	IP66/67
Cable entry	thru-holes direct through body
Gland plate on face(s)	n/a
Defined entry area	
Faces A and B	80 mm x 215 mm
Faces C and D	80 mm x 146 mm
Terminal assembly	
Rail orientation	vertical or horizontal
Number of rails	vertical: 2 horizontal: 2
Usable length per rail	vertical: 180 mm horizontal: 165 mm
Material	
Enclosure	1.5 mm mild steel CR4
Finish	powder coated RAL 7032
Seal	one piece closed cell neoprene

Mass	approx. 3.7 kg
Mounting	2x thru-holes Ø11 mm 2x hook feet with 11 mm wide slots
Grounding	M10 internal/external brass grounding bolt M6 internal stainless steel grounding bolt welded to lid M6 internal stainless steel grounding bolt welded to body
Data for application in connection with Ex-areas	
EC-Type Examination Certificate	SIRA 99 ATEX 3199
Group, category, type of protection, temperature class	⊕ Ex II 1 G, ⊕ Ex II 2 D Ex ia IIC T6 Ga, Ex tb IIIC T80 °C Db (ta ... +40°C) Ex ia IIC T5 Ga, Ex tb IIIC T95 °C Db (ta ... +55°C) Ex ia IIC T4 Ga, Ex tb IIIC T130 °C Db (ta ... +85°C)
Maximum power dissipation	15 W
International approvals	
IECEX approval	IECEX SIR 06.0074
GOST-R approval	GOST-R B01008
General information	
Supplementary information	EC-Type Examination Certificate, Statement of Conformity, Declaration of Conformity, Attestation of Conformity and instructions have to be observed where applicable. For information see www.pepperl-fuchs.com .
Accessories	
Optional accessories	Equipment mounting plate, same material as box M10 internal/external stainless steel grounding bolt

Guide to Entry Capacity

Gland size mm	20	25	32
Side A + B	12	9	4
Side C + D	8	6	3