

3RG4033-3AD01-PF	NO or NC / Schließer o. Öffner	Connector M12 / Stecker M12
3RG4033-6AD01-PF	NO or NC / Schließer o. Öffner	screw terminals / Schraubklemmen

Size / Bauform		80x100 mm block / kubisch 80x100 mm
Mounting / Einbau		embeddable / non-embeddable / bündig / nicht bündig

Operating distance / Schaltabstand			
Rated operating distance / Bemessungsschaltabstand	sn	40 mm (embeddable / bündig) 30 mm (non-embeddable / nicht bündig)	
Effective operating distance / Realschaltabstand	sr	36 ... 44 mm (embeddable / bündig) 27 ... 33 mm (non-embeddable / nicht bündig)	
Assured operating distance / Gesicherter Schaltabstand	sa	32 mm (embeddable / bündig) 24 mm (non-embeddable / nicht bündig)	
Standard target mild steel / Meßplatte Stahlfahne St37		120 x 120 x 1 mm	
Repeat accuracy / Wiederholgenauigkeit	R	2 mm	
Hysteresis / Hysterese	H	0,05 mm ... 8,8 mm	
Reduction factors / Reproduktionsfaktoren		Al:	0,40
		Cu:	0,30
		Ms:	0,40
		Stainl. steel / Edelstahl:	0,70

Power supply voltage / Versorgungsspannung		
Rated operational voltage / Bemessungsbetriebsspannung	Ue	24 DC
Operating voltage range / Betriebsspannungsbereich	UB	10... 65 DC
No-load supply current / Leerlaufstrom	Io	300 mA
max. ripple content / zul.Restwelligkeit		10%

Output / Ausgang		
Output / Ausgangsart		3 wire DC pnp / 3 Leiter DC pnp
Rated operational current / Bemessungsbetriebsstrom	Ie	200 mA (to / bis 50° Cel); 150 mA (to / bis 85° Cel)
Output voltage drop / Spannungsfall max.	Ud	2,5 V
Off-state current / Reststrom		0,01 mA
Short-circuit strength / Kurzschlußfestigkeit		built-in / eingebaut
Overload withstand capability / Überlastfestigkeit		built-in / eingebaut

Times / Zeiten		
Frequency of operating cycles / Schaltfrequenz	f	10 Hz
Time delay before availability / Bereitschaftsverzug	tv	200 ms

Temperatures / Temperaturen		
Rated temperature / Bemessungstemperatur	Tu	25 Cel
Ambient temperature range / zul. Umgebungstemperatur	Ta	-25...+85 Cel
Storage temperature range / zul. Lagertemperatur	Ts	-40...+85 Cel

Electrical protections / Elektrische Schutzmaßnahmen, EMV		
Reverse voltage protection / Verpolungsschutz		built-in / eingebaut
Wire breakage protection / Drahtbruchsicherheit		built-in / eingebaut
Inductive overvoltage / Induktionsschutz		built-in / eingebaut
Spurious switching signale / Einschaltfehlimpuls		suppressed / unterdrückt

Mechanical protections / Mechanische Schutzmaßnahmen		
Degree of protection / Schutzart		IP 65
Shock / Schockbeanspruchung		30 x g; 11 ms duration / Einwirkdauer
Vibration / Schwingbeanspruchung		10 bis 55 Hz, 1mm amplitude / Amplitude
Indicators / Anzeigen		LED yellow / gelb (switching status / Schaltzustand), LED green / grün (operating voltage / Betriebssp.)

Rated operating distance 40mm, embeddable / Bemessungsschaltabstand 40mm, bündig:			
Mounting conditions / Einbaubedingungen:			
Side-by-side mounting possibility / Aneinanderreihbarkeit	e>		160 mm
Influence metallic surroundings / Einfluß metallischer Umgebung	r>		80 mm
	g>		--
	w>		--
	c>		90 mm

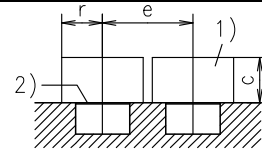

Rated operating distance 30mm, non-embeddable / Schaltabstand 30mm, nicht bündig:			
Mounting conditions / Einbaubedingungen:			
Side-by-side mounting possibility / Aneinanderreihbarkeit	e>		160 mm
Influence metallic surroundings / Einfluß metallischer Umgebung	r>		80 mm
	g>		40 mm
	w>		15 mm
	c>		90 mm
Max. Cable length / max. zulässige Leitungslänge		:	300 m

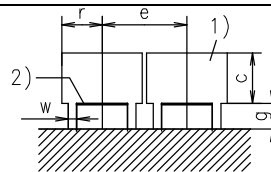

Design characteristics / Konstruktive Merkmale			
Housing material / Gehäuse		:	moulded plastic / Formstoff PBT
Sensing face / Ansprechfläche		:	upwards / nach oben
Weight / Gewicht		:	0,47 kg

Remarks/Bemerkungen:

- 1) free space/Freiraum
- 2) sensing face/aktive Fläche
- 3) Electronic to base attachable/Elektronikteil auf Sockel aufsteckbar
- 4) Bushing Pg 13,5 for cable diameter 6,5 to 13,5 suitable/Leitungseinführung Pg 13,5 für Kabeldurchmesser 6,5 bis 13,5 geeignet

3RG4033-3AD01-PF:

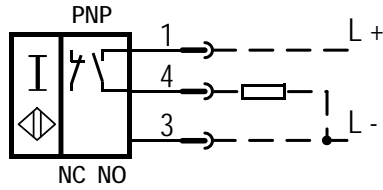

3RG4033-6AD01-PF:

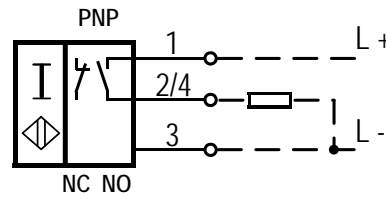

Response characteristics/Ansprechkennlinie:
Rated operating distance 40mm/Schaltabstand 40mm:

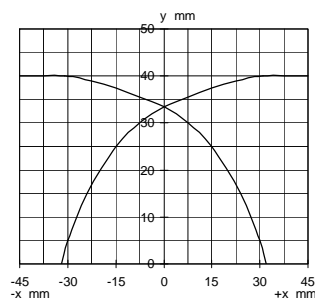

Response characteristics/Ansprechkennlinie:
Rated operating distance 30mm/Schaltabstand 30mm:

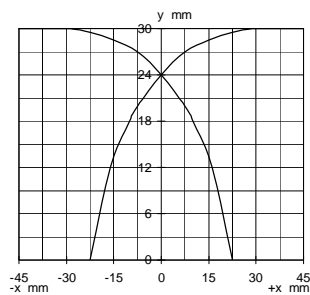

3RG4033-3AD01-PF:

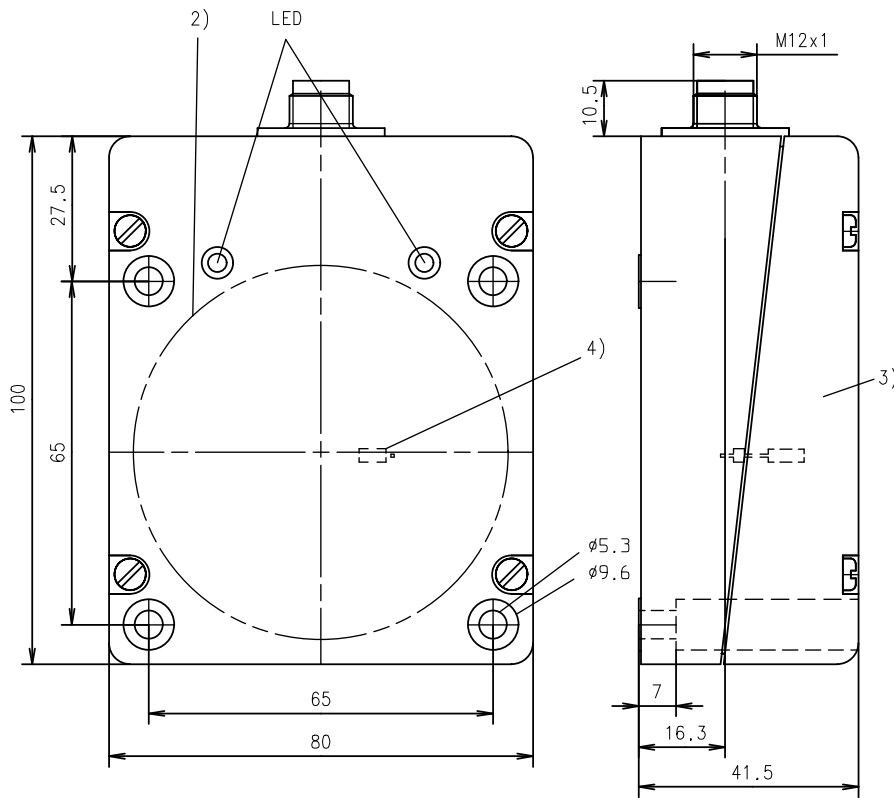

3RG4033-6AD01-PF:

