



**Model Number**

**SU18/16/35/40a/110/115a/126a**

Fiber optic sensor  
200 mm fixed cable with 4-pin, M8x1 connector

**Features**

- Basic line for DIN rail installation
- High power version
- Sleek design
- 3 response times selectable
- Protected against mutual interference (no crosstalk)
- Self diagnosis function

**Dimensions**

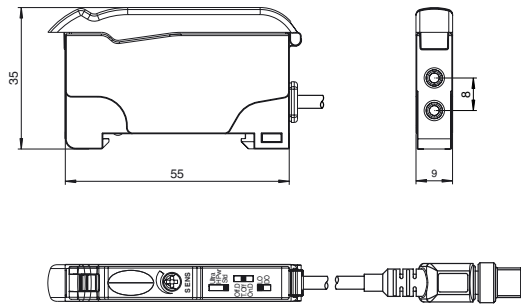

**Electrical connection**

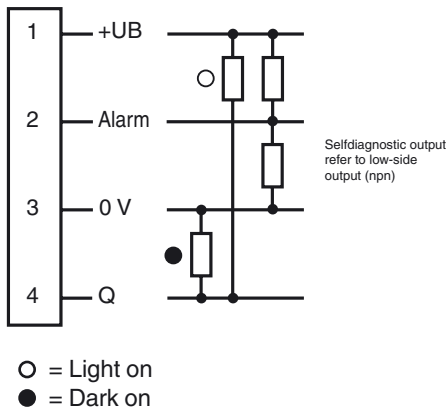

**Pinout**



Release date: 2011-09-16 13:43 Date of issue: 2011-10-20 808701\_eng.xml

Subject to modifications without notice

Pepperl+Fuchs Group  
www.pepperl-fuchs.com

USA: +1 330 486 0001  
fa-info@us.pepperl-fuchs.com

Germany: +49 621 776-4411  
fa-info@pepperl-fuchs.com

Copyright Pepperl+Fuchs  
Singapore: +65 6779 9091  
fa-info@sg.pepperl-fuchs.com

**Technical data****General specifications**

Sensor range	up to 460 mm (KLR-C02-2,2-2,0-K146)
Detection range	up to 1500 mm (KLE-C01-2,2-2,0-K116)
Light source	LED
Light type	modulated visible red light , 640 nm
Ambient light limit	10000 Lux

**Functional safety related parameters**

MTTF <sub>d</sub>	690 a
Mission Time (T <sub>M</sub> )	20 a
Diagnostic Coverage (DC)	0 %

**Indicators/operating means**

Operating display	LED green, statically lit Power on , Undervoltage indicator: Green LED, pulsing (approx. 0.8 Hz) , short-circuit : LED green flashing (approx. 4 Hz)
Function display	LED yellow: static illumination switching state, flashes when falling short of the stability control
Controls	Potentiometer for setting sensitivity slide switch 2 positions: light/dark switching slide switch 3 positions: timer function - timer off, on delay 40 ms, off-delay 40 ms slide switch 3 positions: operating mode - Standard, High Power, Ultra

**Electrical specifications**

Operating voltage	U <sub>B</sub>	10 ... 30 V DC
Ripple		10 %
No-load supply current	I <sub>0</sub>	≤ 30 mA

**Output**

Output of the pre-fault indication	1 push-pull output NPN/PNP , short-circuit protected	
Switching type	light/dark on, switchable	
Signal output	1 push-pull output NPN/PNP , short-circuit protected	
Switching voltage	max. 30 V DC	
Switching current	max. 100 mA , resistive load	
Voltage drop	U <sub>d</sub>	≤ 2 V DC at 100 mA ; ≤ 0.7 V at 10 mA
Switching frequency	f	Standard mode: 3 kHz , High power mode: 1 kHz , Ultra mode: 100 Hz
Response time		Standard mode: 160 μs , High power mode: 500 μs , Ultra mode: 5 ms
Repeat accuracy	R	≤ 0.5 % of adjusted sensor range

**Ambient conditions**

Ambient temperature	-10 ... 55 °C (14 ... 131 °F)
Storage temperature	-20 ... 70 °C (-4 ... 158 °F)

**Mechanical specifications**

Protection degree	IP50
Connection	200 mm, PVC cable with M8 connector, 4-pin
Material	
Housing	PC
Mass	45 g

**Compliance with standards and directives**

Standard conformity	
Product standard	EN 60947-5-2:2007 IEC 60947-5-2:2007

**Approvals and certificates**

UL approval	cULus Listed, Class 2 Power Source, Type 1 enclosure
CCC approval	Products with a maximum operating voltage of ≤36 V do not bear a CCC marking because they do not require approval.

**Accessories****KLR-C02-2,2-2,0-K146**

Plastic fiber optic - diffuse

**KLR-C02-2,2-2,0-K70**

Plastic fiber optic - diffuse

**KLR-C02-1,0-2,0-K75**

Plastic fiber optic - diffuse

**KLR-C09-1,25-2,0-K76**

Plastic fiber optic - diffuse

**KLR-C09-1,25-2,0-K74**

Plastic fiber optic - diffuse

**KLR-C16-2,2-2,0-K71**

Plastic fiber optic - diffuse

**KLR-A32-2,2-2,0-K83**

Plastic fiber optic - diffuse

**KHR-C02-2,2-2,0-K131**

Plastic fiber optic - diffuse

**KHTR-C02-2,2-2,0-K88**

Plastic fiber optic - diffuse

**LHR 00-0,8-1,0-20M4**

Glass fiber optic - diffuse with silicon covering

**KLE-C01-2,2-2,0-K116**

Plastic fiber optic - thru-beam

**KLE-C01-2,2-2,0-K103**

Plastic fiber optic - thru-beam

**KLE-C01-2,2-2,0-K102**

Plastic fiber optic - thru-beam

**KLE-C01-2,2-2,0-K100**

Plastic fiber optic - thru-beam

**KLE-C01-2,2-2,0-K101**

Plastic fiber optic - thru-beam

**KLE-C01-2,2-2,0-K113**

Plastic fiber optic - thru-beam

**KLE-C01-1,0-2,0-K120**

Plastic fiber optic - thru-beam

**KHE-C01-2,2-2,0-K122**

Plastic fiber optic - thru-beam

**KHTE-C01-2,2-2,0-K118**

Plastic fiber optic - thru-beam

**LHE 00-1,1-1,0-20M4**

Glass fiber optic - thru-beam with silicon covering

**Bracket SU**

Mounting bracket for DIN rail

Other suitable accessories can be found at [www.pepperl-fuchs.com](http://www.pepperl-fuchs.com)

**Curves/Diagrams**

**Self-Diagnostic definition and operation:**

5 sec. rule for light-ON (LO) and dark-ON (DO) mode

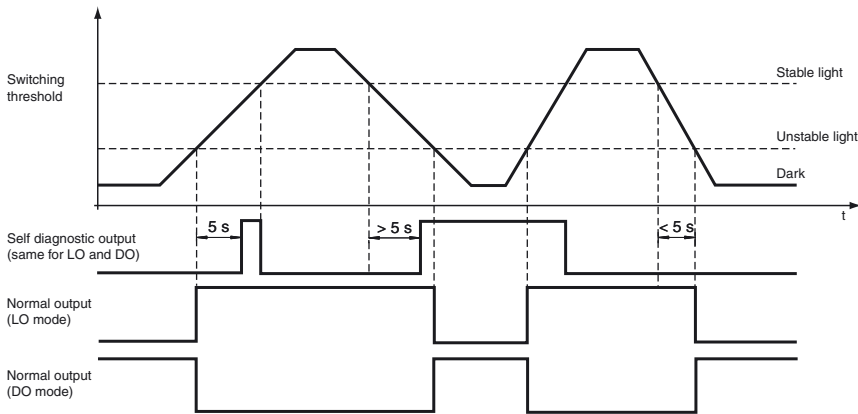

8 cyc. rule for light-ON (LO) and dark-ON (DO) mode

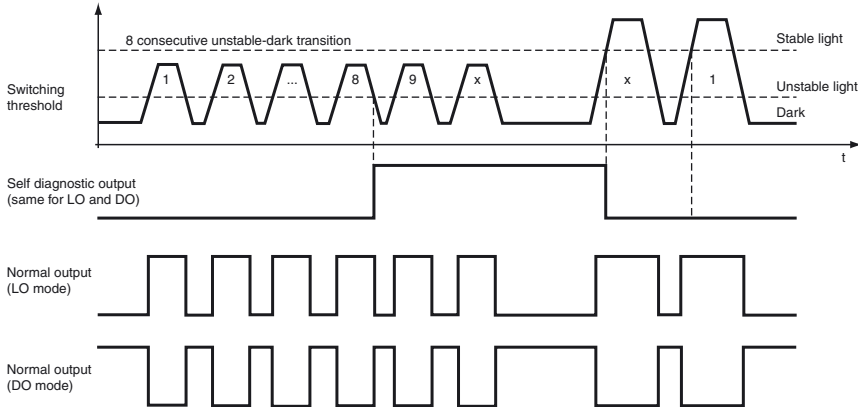

**LED indicators and operating chart:**

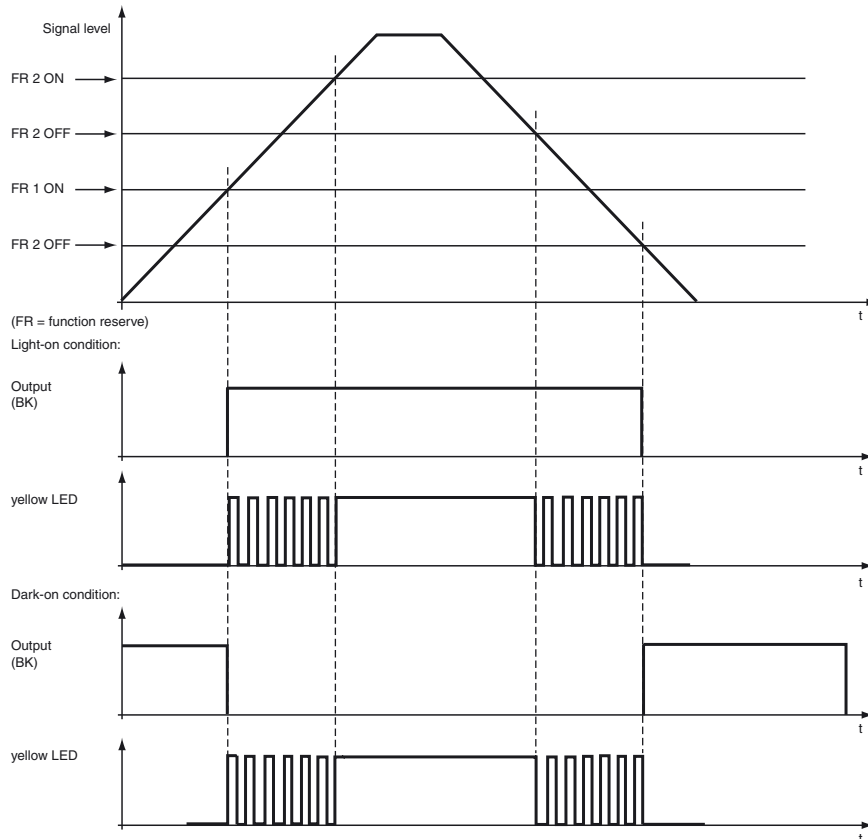

Release date: 2011-09-16 13:43 Date of issue: 2011-10-20 808701\_eng.xml

**Indications**

Subject to modifications without notice

Pepperl+Fuchs Group  
www.pepperl-fuchs.com

USA: +1 330 486 0001  
fa-info@us.pepperl-fuchs.com

Germany: +49 621 776-4411  
fa-info@pepperl-fuchs.com

Copyright Pepperl+Fuchs

Singapore: +65 6779 9091  
fa-info@sg.pepperl-fuchs.com

**Indications for the Green and Yellow LEDs in detection mode (normal operation):**

- Yellow LED is stable ON to indicate that signal received is > FR2
- Yellow LED will flash at 4 Hz to indicate function reserve, FR1 < signal level < FR2
- Green LED stable ON to indicate power supply is ON, sensor is ready.
- Green LED will flash once for each key actuation, e.g. actuation of the Teach button
- Green LED will flash at 4 Hz to indicate a short-circuit fault at the output(s)
- Green LED will flash at 0.8 Hz to indicate an under voltage fault at the power supply

**Selection table - thru-beam fiber optic cable**

Head shape	Moun-ting	Model number	Core	Detection distance *	Fiber cross section	minimum Object size	Fiber optic length	Bend radius	Dimensions	Special features
<b>Highly precise</b>										
Threaded	M3	KLE-C01-1.0-2.0-K120	PMMA	Ultra: 80 mm HiPwr: 45 mm Std: 20 mm	0.25 mm	0.05 mm	2 m	min. 10 mm		
Threaded	M4	KLE-C01-1.0-2.0-K119	PMMA	Ultra: 80 mm HiPwr: 45 mm Std: 20 mm	0.25 mm	0.05 mm	2 m	min. 10 mm		4 x high Detection range with Auxiliary lens K-LA01/ 8 x high Detection range with Auxiliary lens K-LA06/ Side view / Periscope with K-LA02
Threaded	M3 x 0.5	KLE-C04-1.0-2.0-K104	PMMA	Ultra: 300 mm HiPwr: 165 mm Std: 70 mm	4 x 0.25 mm	0.12 mm	2 m	min. 15 mm		
Cylindrical	dia. 2 mm	KLE-C01-1.0-2.0-K105	PMMA	Ultra: 80 mm HiPwr: 45 mm Std: 20 mm	0.25 mm	0.05 mm	2 m	min. 10 mm		
Cylindrical	dia. 1.5 mm	KLE-C01-1.0-2.0-K107	PMMA	Ultra: 80 mm HiPwr: 45 mm Std: 20 mm	0.25 mm	0.05 mm	2 m	min. 10 mm		
Cylindrical	dia. 1.5 mm	KLE-C04-1.0-2.0-K108	PMMA	Ultra: 300 mm HiPwr: 165 mm Std: 70 mm	4 x 0.25 mm	0.12 mm	2 m	min. 15 mm		
Cylindrical	dia. 2 mm	KLE-C04-1.0-2.0-K106	PMMA	Ultra: 300 mm HiPwr: 165 mm Std: 70 mm	4 x 0.25 mm	0.05 mm	2 m	min. 15 mm		
<b>Highly flexible</b>										
Threaded	M3	KHE-C01-1.0-2.0-K125	PMMA	Ultra: 210 mm HiPwr: 120 mm Std: 50 mm	0.5 mm	0.15 mm	2 m	min. 1 mm		only 1 mm Bend radius
Threaded	M3	KHE-C01-2.2-2.0-K122	PMMA	Ultra: 800 mm HiPwr: 480 mm Std: 200 mm	1 mm	0.25 mm	2 m	min. 2 mm		only 2 mm Bend radius

Release date: 2011-09-16 13:43 Date of issue: 2011-10-20 808701\_eng.xml

Head shape	Moun-ting	Model number	Core	Detection distance *	Fiber cross section	minimum Object size	Fiber optic length	Bend radius	Dimensions	Special features
Threaded	M4 x 0.7 /M2.6	KHE-C01-1.0-2.0-K124	PMMA	Ultra: 210 mm HiPwr: 120 mm Std: 50 mm	0.5 mm	0.15 mm	2 m	min. 1 mm		4 x high Detection range with Auxiliary lens K-LA01/ 8 x high Detection range with Auxiliary lens K-LA06 Side view / Periscope with K-LA02/ only 1 mm Bend radius
Threaded	M6	KHE-C01-2.2-2.0-K121	PMMA	Ultra: 800 mm HiPwr: 480 mm Std: 200 mm	1.0 mm	0.25 mm	2 m	min. 2 mm		only 2 mm Bend radius
Cylindrical	dia. 1.5 mm	KHE-C01-1.0-2.0-K139	PMMA	Ultra: 210 mm HiPwr: 120 mm Std: 50 mm	0.5 mm	0.05 mm	2 m	min. 1 mm		only 1 mm Bend radius
Cylindrical	dia. 3 mm	KHE-C01-2.2-2.0-K126	PMMA	Ultra: 210 mm HiPwr: 120 mm Std: 50 mm	0.5 mm	0.15 mm	2 m	min. 1 mm		only 1 mm Bend radius
Cylindrical	dia. 3 mm	KHE-C01-2.2-2.0-K123	PMMA	Ultra: 800 mm HiPwr: 480 mm Std: 200 mm	1 mm	0.25 mm	2 m	min. 2 mm		only 2 mm Bend radius
Right angle	dia. 15 x 5	KHE-C01-2.2-2.0-K137	PMMA	Ultra: 140 mm HiPwr: 80 mm Std: 35 mm	0.5 mm	0.15 mm	2 m	min. 1 mm		only 1 mm Bend radius
Right angle	dia. 15 x 5	KHE-C01-2.2-2.0-K140	PMMA	Ultra: 600 mm HiPwr: 350 mm Std: 150 mm	1 mm	0.25 mm	2 m	min. 2 mm		only 2 mm Bend radius
Flexible										
Threaded	M3 x 0.5 /M2.6	KLE-C01-1.3-2.0-K112	PMMA	Ultra: 800 mm HiPwr: 480 mm Std: 200 mm	1 mm	0.25 mm	2 m	min. 25 mm		4 x high Detection range with Auxiliary lens K-LA01/ 8 x high Detection range with Auxiliary lens K-LA06 Side view / Periscope with K-LA02
Threaded	M3 x 0.5	KLE-C01-2.2-2.0-K103	PMMA	Ultra: 920 mm HiPwr: 520 mm Std: 220 mm	1 mm	0.25 mm	2 m	min. 25 mm		
Threaded	M4 x 0.7 /M2.6	KLE-C01-2.2-2.0-K102	PMMA	Ultra: 920 mm HiPwr: 520 mm Std: 220 mm	1 mm	0.25 mm	2 m	min. 25 mm		4 x high Detection range with Auxiliary lens K-LA01/ 8 x high Detection range with Auxiliary lens K-LA06 Side view / Periscope with K-LA02
Threaded	M6	KLE-C01-2.2-2.0-K100	PMMA	Ultra: 920 mm HiPwr: 520 mm Std: 220 mm	1 mm	0.32 mm	2 m	min. 25 mm		

Release date: 2011-09-16 13:43 Date of issue: 2011-10-20 808701\_eng.xml

Subject to modifications without notice

Pepperl+Fuchs Group  
www.pepperl-fuchs.com

USA: +1 330 486 0001  
fa-info@us.pepperl-fuchs.com

Germany: +49 621 776-4411  
fa-info@pepperl-fuchs.com

Copyright Pepperl+Fuchs

Singapore: +65 6779 9091  
fa-info@sg.pepperl-fuchs.com

**PF** PEPPERL+FUCHS  
SENSING YOUR NEEDS

Head shape	Moun-ting	Model number	Core	Detection distance *	Fiber cross section	minimum Object size	Fiber optic length	Bend radius	Dimensions	Special features
Threaded	M2.6	KLE-C01-2.2-2.0-K113	PMMA	Ultra: 800 mm HiPwr: 480 mm Std: 200 mm	1 mm	0.25 mm	2 m	min. 25 mm		4 x high Detection range with Auxiliary lens K-LA01/ 8 x high Detection range with Auxiliary lens K-LA06 Side view / Periscope with K-LA02
Cylindrical	dia. 2 mm	KLE-C01-1.3-2.0-K114	PMMA	Ultra: 920 mm HiPwr: 520 mm Std: 220 mm	1 mm	0.25 mm	2 m	min. 25 mm		
Cylindrical	dia. 5 mm	KLE-C01-2.2-2.0-K101	PMMA	Ultra: 920 mm HiPwr: 520 mm Std: 220 mm	1 mm	0.32 mm	2 m	min. 25 mm		
<b>Bendable tip</b>										
Threaded	M4	KLE 00-2.2-2.0-K55	PMMA	Ultra: 872 mm HiPwr: 500 mm Std: 228 mm	1 mm		2 m	min. 25 mm		
<b>High detection range</b>										
Threaded	M3	KLE-C01-2.2-2.0-K116	PMMA	Ultra: 1500 mm HiPwr: 950 mm Std: 450 mm	1.5 mm	0.35 mm	2 m	min. 40 mm		
Threaded	M6	KLE-C01-2.2-2.0-K115	PMMA	Ultra: 1500 mm HiPwr: 950 mm Std: 450 mm	1.5 mm	0.35 mm	2 m	min. 40 mm		
Threaded	M8 x 1	FEF-PLT1	PMMA	Ultra: 25620 mm HiPwr: 15070 mm Std: 6000 mm calculated values related on 2 m Fiber optic length	1 mm		1 m	min. 25 mm		Narrow beam
Threaded	M8 x 1	FEF-PLT1-L2	PMMA	Ultra: 25620 mm HiPwr: 15070 mm Std: 6000 mm calculated values related on 2 m Fiber optic length	1 mm		2 m	min. 25 mm		Narrow beam
Threaded	M8 x 1	FEF-PLT1-L5	PMMA	Ultra: 25620 mm HiPwr: 15070 mm Std: 6000 mm calculated values related on 2 m Fiber optic length	1 mm		4 m	min. 25 mm		Narrow beam
Cylindrical	dia. 3 mm	KLE-C01-2.2-2.0-K117	PMMA	Ultra: 1360 mm HiPwr: 820 mm Std: 400 mm	1.5 mm	0.35 mm	2 m	min. 25 mm		
<b>Side view / Periscope</b>										
Cylindrical	dia. 4.75 mm	KHE-C01-2.2-2.0-K136	PMMA	Ultra: 200 mm HiPwr: 110 mm Std: 50 mm	0.5 mm	0.15 mm	2 m	min. 1 mm		only 1 mm Bend radius

Release date: 2011-09-16 13:43 Date of issue: 2011-10-20 808701\_eng.xml

Head shape	Moun-ting	Model number	Core	Detection distance *	Fiber cross section	minimum Object size	Fiber optic length	Bend radius	Dimensions	Special features
<b>Array</b>										
Rectangular	3 x M2 x 0.5	KLE-A16-2.2-2.0-K109	PMMA	Ultra: 420 mm HiPwr: 240 mm Std: 100 mm	16 x 0.25 mm	0.05 mm	2 m	min. 25 mm		
Rectangular	3 x M3 x 0.5	KLE-A16-2.2-2.0-K110	PMMA	Ultra: 420 mm HiPwr: 240 mm Std: 100 mm	16 x 0.25 mm	0.05 mm	2 m	min. 25 mm		
Rectangular	3 x M3 x 0.5	KLE-A16-2.2-2.0-K111	PMMA	Ultra: 420 mm HiPwr: 240 mm Std: 100 mm	16 x 0.25 mm	0.05 mm	2 m	min. 25 mm		
Rectangular	2 x 3.2 mm	KLE-A32-2.2-2.0-K142	PMMA	Ultra: 140 mm HiPwr: 80 mm Std: 35 mm	32 x 0.25 mm		2 m	min. 25 mm		
<b>High temperature resistance</b>										
Cylindrical	dia. 3 mm	KHTE-C01-2.2-2.0-K118	PMMA	Ultra: 475 mm HiPwr: 270 mm Std: 115 mm	1 mm	0.35 mm	2 m	min. 25 mm		- 55°C ... + 115 °C
<b>Sturdy design</b>										
Threaded	M3	LHE 00-1.1-1.0-14M3	glass	Ultra: 710 mm HiPwr: 420 mm Std: 195 mm	1.1 mm		1 m	4 mm static		- 40°C ... + 180 °C
Threaded	M4 x 0.7 /M2.6	LHE 00-1.1-1.0-20M4	glass	Ultra: 710 mm HiPwr: 420 mm Std: 195 mm	1.1 mm		1 m	4 mm static		4 x high Detection range with Auxiliary lens K-LA01/ 8 x high Detection range with Auxiliary lens K-LA06 Side view / Periscope with K-LA02/ - 40°C ... + 180 °C
Threaded	M6	LHE 00-1.1-1.0-G	glass	Ultra: 710 mm HiPwr: 420 mm Std: 195 mm	1.1 mm		1 m	4 mm static		- 40°C ... + 180 °C
Cylindrical	dia. 1.5 mm	LHE 00-1.1-1.0-10C1.5	glass	Ultra: 710 mm HiPwr: 420 mm Std: 195 mm	1.1 mm		1 m	4 mm static		- 40°C ... + 180 °C
Cylindrical	dia. 3 mm	LHE 00-1.1-1.0-15C3	glass	Ultra: 710 mm HiPwr: 420 mm Std: 195 mm	1.1 mm		1 m	4 mm static		- 40°C ... + 180 °C
Right angle	Bar 3 mm	LHE 00-1.1-1.0-WC3	glass	Ultra: 710 mm HiPwr: 420 mm Std: 195 mm	1.1 mm		1 m	4 mm static		- 40°C ... + 180 °C

Release date: 2011-09-16 13:43 Date of issue: 2011-10-20 808701\_eng.xml

Subject to modifications without notice



Head shape	Moun-ting	Model number	Core	Detection distance *	Fiber cross section	minimum Object size	Fiber optic length	Bend radius	Dimensions	Special features
Right angle	Bar 10 mm	LHE 00-1.1-1.0-K9	glass	Ultra: 710 mm HiPwr: 420 mm Std: 195 mm	1.1 mm		1 m	4 mm static		- 40°C ... + 180 °C
<b>Special design</b>										
Rectangular	2 x 2.2 mm	KHE-A01-1.0-2.0-K138	PMMA	Ultra: 100 mm HiPwr: 60 mm Std: 25 mm	0.5 mm	0.05 mm	2 m	min. 1 mm		only 1 mm Bend radius
Slot	2 x 3.2 mm	KLE-C02-1.25-2.0-K134	PMMA	5 mm	2 x 0.25 mm		2 m	min. 10 mm		
Slot	2 x 3.2 mm	KLE-C02-1.25-2.0-K135	PMMA	10 mm	2 x 0.25 mm		2 m	min. 10 mm		

	Std: Standard Mode, 160 µs HiPwr: HighPower Mode, 500 µs Ultra: Ultra Mode, 5 ms
--	--

**Selection table - diffuse mode fiber optic cable**

Head shape	Mounting	Model number	Core	Detection distance *	Fiber cross-section	Fiber optic length	Bend radius	Dimensions	Special features	
<b>Highly precise</b>										
Threaded	M3 x 0.5	KLR-C02-1.0-2.0-K75	PMMA	Ultra: 12 mm HiPwr: 6 mm Std: 4 mm	2 x 0.25 mm	2 m	min. 10 mm			
Threaded	M4 x 0.7	KLR-C02-1.0-2.0-K73	PMMA	Ultra: 12 mm HiPwr: 6 mm Std: 4 mm	2 x 0.25 mm	2 m	min. 10 mm			
Threaded	M3 x 0.5	KLR-C04-1.25-2.0-K78	PMMA	Ultra: 25 mm HiPwr: 18 mm Std: 8 mm	4 x 0.25 mm	2 m	min. 15 mm			
Cylindrical	dia. 2.0 mm	KLR-C02-1.0-2.0-K91	PMMA	Ultra: 12 mm HiPwr: 6 mm Std: 4 mm	2 x 0.25 mm	2 m	min. 10 mm			
Cylindrical	dia. 3.0 mm	KLR-C02-1.0-2.0-K90	PMMA	Ultra: 12 mm HiPwr: 6 mm Std: 4 mm	2 x 0.25 mm	2 m	min. 10 mm			

Release date: 2011-09-16 13:43 Date of issue: 2011-10-20 808701\_eng.xml



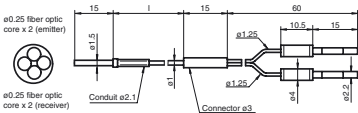
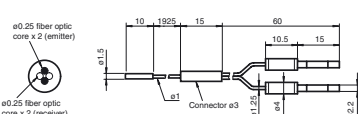
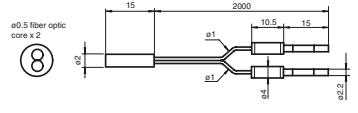
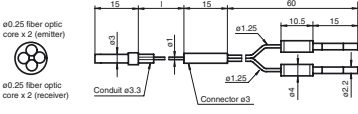
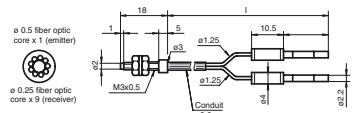
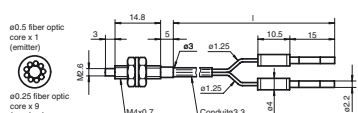
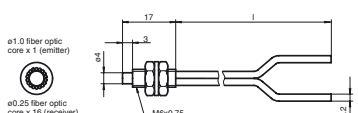
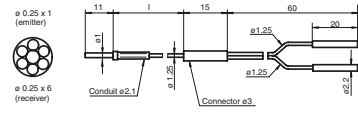
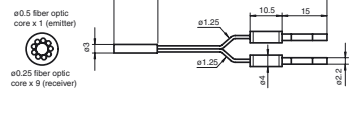
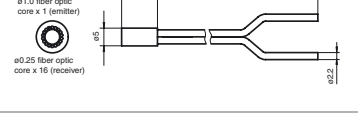
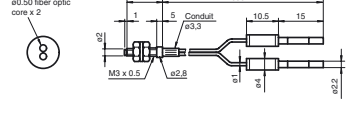

Head shape	Mounting	Model number	Core	Detection distance *	Fiber cross-section	Fiber optic length	Bend radius	Dimensions	Special features
Cylindrical	dia. 1.5 mm	KLR-C04-1.25-2.0-K80	PMMA	Ultra: 25 mm HiPwr: 18 mm Std: 8 mm	4 x 0.25 mm	2 m	min. 15 mm		
Cylindrical	dia. 1.5 mm	KLR-C04-1.0-2.0-K133	PMMA	Ultra: 25 mm HiPwr: 18 mm Std: 7 mm	4 x 0.25 mm	2 m	min. 15 mm		
Cylindrical	dia. 2.0 mm	KLR-C02-1.0-2.0-K87	PMMA	Ultra: 85 mm HiPwr: 52 mm Std: 25 mm	2 x 0.5 mm	2 m	min. 15 mm		
Cylindrical	dia. 3.0 mm	KLR-C04-1.25-2.0-K79	PMMA	Ultra: 25 mm HiPwr: 18 mm Std: 8 mm	4 x 0.25 mm	2 m	min. 15 mm		
<b>Coaxial</b>									
Threaded	M3 x 0.5	KLR-C09-1.25-2.0-K76	PMMA	Ultra: 100 mm HiPwr: 60 mm Std: 30 mm	1 x 0.5 mm Emitter 9 x 0.25 mm Receiver	2 m	min. 15 mm		only 0.5 mm light spot at 8 mm with auxiliary lens K-LA03
Threaded	M4 x 0.7 /M2.6	KLR-C09-1.25-2.0-K74	PMMA	Ultra: 100 mm HiPwr: 60 mm Std: 30 mm	1 x 0.5 mm Emitter 9 x 0.25 mm Receiver	2 m	min. 15 mm		only 0.7 mm light spot at 10 mm with auxiliary lens K-LA04/ 2 x high Detection range with Auxiliary lens K-LA01/ 3 x high Detection range with Auxiliary lens K-LA06
Threaded	M6 x 0.75	KLR-C16-2.2-2.0-K71	PMMA	Ultra: 300 mm HiPwr: 190 mm Std: 85 mm	1 x 1.0 mm Emitter 16 x 0.25 mm Receiver	2 m	min. 25 mm		
Cylindrical	dia. 1.0 mm	KLR-C06-1.25-2.0-K81	PMMA	Ultra: 70 mm HiPwr: 45 mm Std: 20 mm	1 x 0.25 mm Emitter 6 x 0.25 mm Receiver	2 m	min. 15 mm		
Cylindrical	dia. 3.0 mm	KLR-C09-1.25-2.0-K77	PMMA	Ultra: 110 mm HiPwr: 60 mm Std: 30 mm	1 x 0.5 mm Emitter 9 x 0.25 mm Receiver	2 m	min. 15 mm		
Cylindrical	dia. 5.0 mm	KLR-C16-2.2-2.0-K72	PMMA	Ultra: 300 mm HiPwr: 190 mm Std: 85 mm	1 x 1.0 mm Emitter 16 x 0.25 mm Receiver	2 m	min. 25 mm		
<b>Highly flexible</b>									
Threaded	M3	KHR-C02-1.0-2.0-K96	PMMA	Ultra: 40 mm HiPwr: 25 mm Std: 12 mm	2 x 0.5 mm	2 m	min. 1 mm		

Release date: 2011-09-16 13:43 Date of issue: 2011-10-20 808701\_eng.xml

Subject to modifications without notice

Pepperl+Fuchs Group  
www.pepperl-fuchs.com

USA: +1 330 486 0001  
fa-info@us.pepperl-fuchs.com

Germany: +49 621 776-4411  
fa-info@pepperl-fuchs.com

Copyright Pepperl+Fuchs  
Singapore: +65 6779 9091  
fa-info@sg.pepperl-fuchs.com

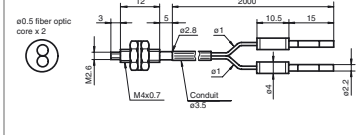
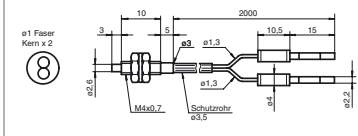
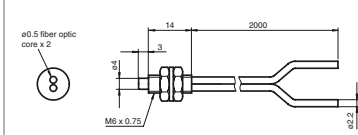
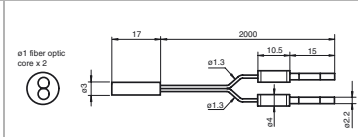
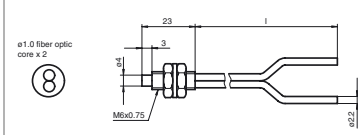
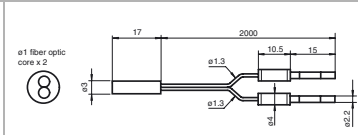
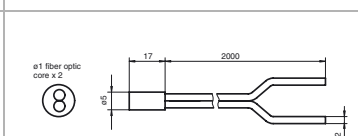
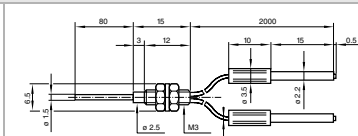
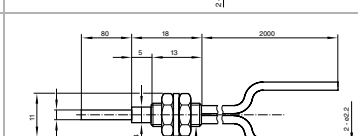
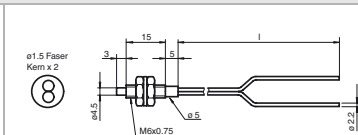
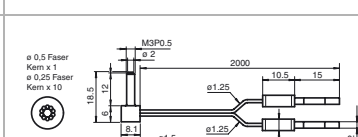
Head shape	Mounting	Model number	Core	Detection distance *	Fiber cross-section	Fiber optic length	Bend radius	Dimensions	Special features
Threaded	M4	KHR-C02-1.0-2.0-K95	PMMA	Ultra: 40 mm HiPwr: 25 mm Std: 12 mm	2 x 0.5 mm	2 m	min. 1 mm		
Threaded	M4	KHR-C02-1.3-2.0-K92	PMMA	Ultra: 210 mm HiPwr: 130 mm Std: 60 mm	2 x 1.0 mm	2 m	min. 2 mm		
Threaded	M6	KHR-C02-2.2-2.0-K94	PMMA	Ultra: 40 mm HiPwr: 25 mm Std: 12 mm	2 x 0.5 mm	2 m	min. 1 mm		
Cylindrical	dia. 3.0 mm	KHR-C02-1.3-2.0-K93	PMMA	Ultra: 200 mm HiPwr: 130 mm Std: 60 mm	2 x 1.0 mm	2 m	min. 2 mm		
Flexible									
Threaded	M6 x 0.75	KLR-C02-2.2-2.0-K70	PMMA	Ultra: 280 mm HiPwr: 180 mm Std: 80 mm	2 x 1.0 mm	2 m	min. 25 mm		
Cylindrical	dia. 3.0 mm	KLR-C02-1.3-2.0-K86	PMMA	Ultra: 280 mm HiPwr: 180 mm Std: 80 mm	2 x 1.0 mm	2 m	min. 25 mm		
Cylindrical	dia. 5.0 mm	KLR-C02-2.2-2.0-K85	PMMA	Ultra: 280 mm HiPwr: 180 mm Std: 80 mm	2 x 1.0 mm	2 m	min. 25 mm		
Bendable tip									
Threaded	M3 x 0.5	KLR 00-1.0-2.0-K58	PMMA	Ultra: 68 mm HiPwr: 40 mm Std: 20 mm		2 m	min. 15 mm		
Threaded	M6	KLR 00-2.2-2.0-K57	PMMA	Ultra: 210 mm HiPwr: 130 mm Std: 60 mm		2 m	min. 15 mm		
High detection range									
Threaded		KLR-C02-2.2-2.0-K146	PMMA	Ultra: 460 mm HiPwr: 270 mm Std: 150 mm		2 m	mind. 40 mm		
Threaded		KLR-C10-1.25-2.0-K144	PMMA	Ultra: 95 mm HiPwr: 60 mm Std: 30 mm		2 m	mind. 15 mm		
Side view / Periscope									

Release date: 2011-09-16 13:43 Date of issue: 2011-10-20 808701\_eng.xml

Head shape	Mounting	Model number	Core	Detection distance *	Fiber cross-section	Fiber optic length	Bend radius	Dimensions	Special features
Threaded	M6	KHR-C02-2.2-2.0-K131	PMMA	Ultra: 210 mm HiPwr: 135 mm Std: 60 mm	2 x 1.0 mm	2 m	min. 2 mm		only 2 mm Bend radius
Threaded	dia. 5.0 mm	KHR-C02-1.0-2.0-K132	PMMA	Ultra: 52 mm HiPwr: 33 mm Std: 15 mm	2 x 0.5 mm	2 m	min. 1 mm		only 1 mm Bend radius
<b>Array</b>									
Rectangular	3 x M2 x 0.5	KLR-A18-1.3-2.0-K82	PMMA	Ultra: 86 mm HiPwr: 55 mm Std: 25 mm	18 x 0.25 mm	2 m	min. 25 mm		
Rectangular	3 x M3 x 0.5	KLR-A32-2.2-2.0-K83	PMMA	Ultra: 120 mm HiPwr: 78 mm Std: 35 mm	10.85 mm	2 m	min. 25 mm		
Rectangular	2 x 3.2 mm	KLR-A32-2.2-2.0-K141	PMMA	Ultra: 120 mm HiPwr: 78 mm Std: 35 mm	16 x 0.25 mm	2 m	min. 25 mm		
<b>High temperature resistance</b>									
Threaded	M6	KHTR-C02-2.2-2.0-K88	PMMA	Ultra: 280 mm HiPwr: 180 mm Std: 80 mm	2 x 1.0 mm	2 m	min. 25 mm		-55°C ... +115°C
Cylindrical	dia. 5.0 mm	KHTR-C02-2.2-2.0-K89	PMMA	Ultra: 280 mm HiPwr: 180 mm Std: 80 mm	2 x 1.0 mm	2 m	min. 25 mm		-55°C ... +115°C
<b>Sturdy design</b>									
Threaded	M3 x 0.5	LHR 00-0.8-1.0-14M3	glass	Ultra: 195 mm HiPwr: 100 mm Std: 40 mm	0.8 mm	1 m	4 mm static		-40°C ... +180°C
Threaded	M4 x 0.7	LHR 00-0.8-1.0-20M4	glass	Ultra: 195 mm HiPwr: 100 mm Std: 40 mm	0.8 mm	1 m	4 mm static		-40°C ... +180°C
Threaded	M6	LHR 00-1.1-1.0-G	glass	Ultra: 230 mm HiPwr: 156 mm Std: 70 mm	1.1 mm	1 m	4 mm static		-40°C ... +180°C
Cylindrical	dia. 3 mm	LHR 00-1.1-1.0-Z1	glass	Ultra: 230 mm HiPwr: 156 mm Std: 70 mm	1.1 mm	1 m	4 mm static		-40°C ... +180°C

Release date: 2011-09-16 13:43 Date of issue: 2011-10-20 808701\_eng.xml

Subject to modifications without notice

Pepperl+Fuchs Group  
www.pepperl-fuchs.com

USA: +1 330 486 0001  
fa-info@us.pepperl-fuchs.com

Germany: +49 621 776-4411  
fa-info@pepperl-fuchs.com

Copyright Pepperl+Fuchs  
Singapore: +65 6779 9091  
fa-info@sg.pepperl-fuchs.com

Head shape	Mounting	Model number	Core	Detection distance *	Fiber cross-section	Fiber optic length	Bend radius	Dimensions	Special features
Cylindrical	dia. 4.5 mm	LHR 00-1.1-1.0-K1	glass	Ultra: 230 mm HiPwr: 156 mm Std: 70 mm	1.1 mm	1 m	4 mm static		- 40°C ... + 180°C
Right angle	10 mm Bar	LHR 00-1.1-1.0-K9	glass	Ultra: 230 mm HiPwr: 156 mm Std: 70 mm	1.1 mm	1 m	4 mm static		- 40°C ... + 180°C
<b>Special design</b>									
Rectangular		KHR-C02-1.0-2.0-K129	PMMA	5 ~ 10 mm	2 x 0.5 mm	2 m	min. 1 mm		crossed beam to background blanking only 1 mm Bend radius
Rectangular		KLR-C02-1.3-2.0-K130	PMMA	1 - 8 mm	2 x 1.0 mm	2 m	min. 25 mm		crossed beam to background blanking
Rectangular	3 x M3 x 0.5	KHR-A02-2.2-2.0-K127	PMMA	Ultra: 175 mm HiPwr: 112 mm Std: 50 mm	2 x 1.0 mm	2 m	min. 2 mm		only 2 mm Bend radius
Rectangular		KLR-C02-1.25-2.0-K128	PMMA	4-26 mm	2 x 0.5 mm	2 m	min. 15 mm		Level measurement
Cylindrical		KLR-C02-1.25-2.0-K147	PMMA			2 m	mind. 40 mm		Fluid detection

	Std: Standard Mode, 160 µs HiPwr: HighPower Mode, 500 µs Ultra: Ultra Mode, 5 ms
--	--