



**Model Number**

**SU19/110/115/126a**

Fiber optic sensor  
with 2 m fixed cable

**Features**

- Classic line with display
- AGC (Automatic Gain Control) for faster teach-in
- Gang mounting for easy wiring
- Transparency recognition
- 30 µs High Speed Mode
- Master module

**Product information**

The fiber optics amplifier SU19 with display was developed to set a benchmark with the most comfortable and user-friendly interface. This simplicity of the settings decreases the costs of ownership significantly. The whole Teach-In process of objects is time-saving due to an easy Teach-In algorithm. The high resolution 4-digit percentage display indicates current values and thresholds with highest accuracy. Wire-saving and the replacement of devices is designed user-friendly and time-saving due to gang mounting on the rear.

Release date: 2012-11-02 13:54 Date of issue: 2012-11-12 805075\_eng.xml

**Dimensions**

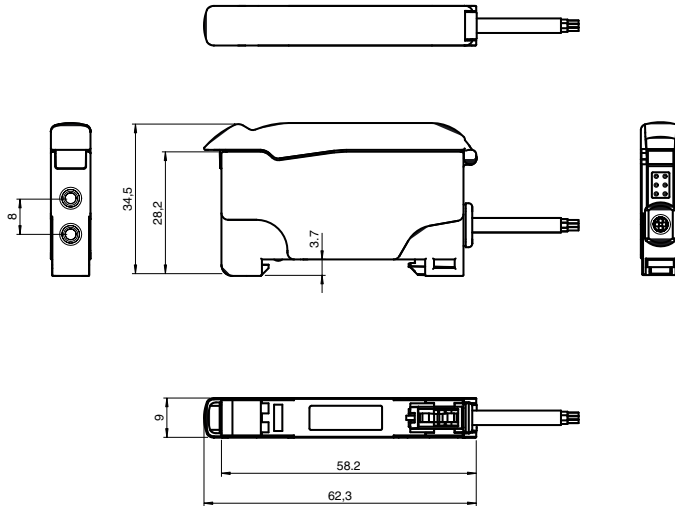

**Electrical connection**

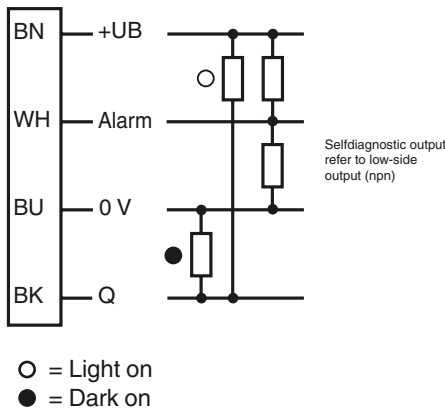

**Indicators/operating means**

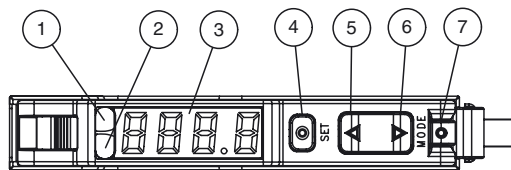

1	Operating display	green
2	Signal display	yellow
3	Display	
4	Button: Set	
5	Button: Up	
6	Button: Down	
7	Button: Mode	

**Technical data****General specifications**

Sensor range	up to 150 mm (KLR-C02-2,2-2,0-K146)
Detection range	up to 450 mm (KLE-C01-2,2-2,0-K116)
Light source	LED
Light type	modulated visible red light , 660 nm
Ambient light limit	10000 Lux
Gang mounting	maximum 20 units

**Functional safety related parameters**

MTTF <sub>d</sub>	500 a
Mission Time (T <sub>M</sub> )	20 a
Diagnostic Coverage (DC)	0 %

**Indicators/operating means**

Operating display	Power on: static illumination , Undervoltage indicator: Green LED, pulsing (approx. 0.8 Hz) , short-circuit : LED green flashing (approx. 4 Hz)
Diagnostics display	7-segment display
Function display	LED yellow: static illumination switching state, flashes when falling short of the stability control
Controls	Button (Mode) for menu choice ; Button (Set) for Teach-In ; Button (Up/Down) for fine adjusting and parameterization

**Electrical specifications**

Operating voltage	U <sub>B</sub>	10 ... 30 V DC
Ripple		10 %
No-load supply current	I <sub>0</sub>	≤ 30 mA

**Output**

Pre-fault indication output	1 push-pull (4 in 1) output NPN/PNP , short-circuit protected	
Switching type	light/dark on selectable programmable	
Signal output	1 push-pull (4 in 1) output NPN/PNP , short-circuit protected	
Switching voltage	max. 30 V DC	
Switching current	max. 100 mA , resistive load	
Voltage drop	U <sub>d</sub>	≤ 2 V DC at 100 mA ; ≤ 0.7 V at 10 mA
Switching frequency	f	High speed mode: 16 kHz , Standard mode: 3 kHz , High resolution: 250 Hz ~ 3 kHz (selection by the sensor), Automatic: 250 Hz , Glass mode: 250 Hz
Response time		High speed mode: 30 μs , Standard mode: 160 μs , High resolution: 2 ms , Automatic: 160 μs ~ 2 ms (choice by the sensor), Glass mode: 2 ms
Repeat accuracy	R	≤ 0.5 % of adjusted sensor range
Timer function		ON-delay, OFF-delay, one shot, pulse extension ; adjustable 0 ... 999 ms in 1 ms increments

**Ambient conditions**

Ambient temperature	-10 ... 55 °C (14 ... 131 °F)
Storage temperature	-20 ... 70 °C (-4 ... 158 °F)

**Mechanical specifications**

Protection degree	IP50
Connection	2 m PVC cable, 4 x 0,14 mm <sup>2</sup>
Material	
Housing	PC
Mass	45 g

**Compliance with standards and directives**

Standard conformity	
Product standard	EN 60947-5-2:2007 IEC 60947-5-2:2007

**Approvals and certificates**

UL approval	cULus Listed, Class 2 Power Source, Type 1 enclosure
CCC approval	Products with a maximum operating voltage of ≤36 V do not bear a CCC marking because they do not require approval.

**Accessories****KLR-C02-2,2-2,0-K146**

Plastic fiber optic - diffuse

**KLR-C02-2,2-2,0-K70**

Plastic fiber optic - diffuse

**KLR-C02-1,0-2,0-K75**

Plastic fiber optic - diffuse

**KLR-C09-1,25-2,0-K76**

Plastic fiber optic - diffuse

**KLR-C09-1,25-2,0-K74**

Plastic fiber optic - diffuse

**KLR-C16-2,2-2,0-K71**

Plastic fiber optic - diffuse

**KLR-A32-2,2-2,0-K83**

Plastic fiber optic - diffuse

**KHR-C02-2,2-2,0-K131**

Plastic fiber optic - diffuse

**KHTR-C02-2,2-2,0-K88**

Plastic fiber optic - diffuse

**LHR 00-0,8-1,0-20M4**

Glass fiber optic - diffuse with silicon covering

**KLE-C01-2,2-2,0-K116**

Plastic fiber optic - thru-beam

**KLE-C01-2,2-2,0-K103**

Plastic fiber optic - thru-beam

**KLE-C01-2,2-2,0-K102**

Plastic fiber optic - thru-beam

**KLE-C01-2,2-2,0-K100**

Plastic fiber optic - thru-beam

**KLE-C01-2,2-2,0-K101**

Plastic fiber optic - thru-beam

**KLE-C01-2,2-2,0-K113**

Plastic fiber optic - thru-beam

**KLE-C01-1,0-2,0-K120**

Plastic fiber optic - thru-beam

**KHE-C01-2,2-2,0-K122**

Plastic fiber optic - thru-beam

**KHTE-C01-2,2-2,0-K118**

Plastic fiber optic - thru-beam

**LHE 00-1,1-1,0-20M4**

Glass fiber optic - thru-beam with silicon covering

**Bracket SU**

Mounting bracket for DIN rail

Other suitable accessories can be found at [www.pepperl-fuchs.com](http://www.pepperl-fuchs.com)

**Curves/Diagrams**

**Self-Diagnostic definition and operation:**

5 sec. rule for light-ON (LO) and dark-ON (DO) mode

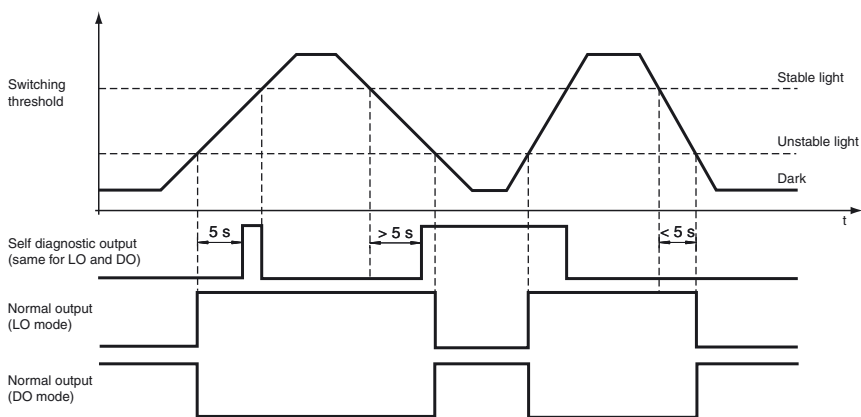

8 cyc. rule for light-ON (LO) and dark-ON (DO) mode

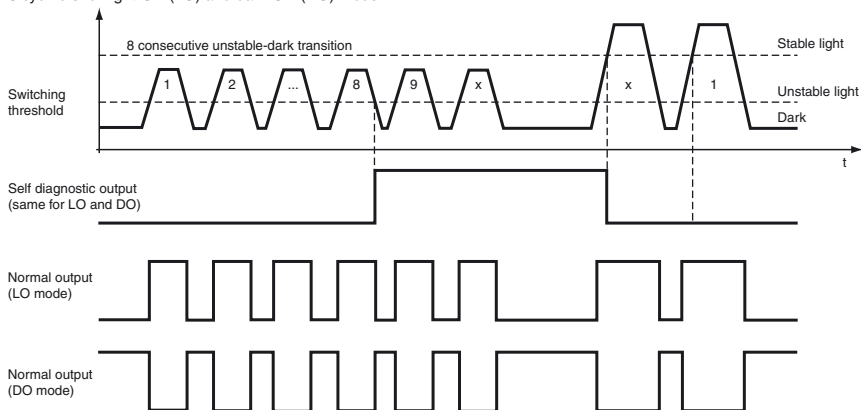

**LED indicators and operating chart:**

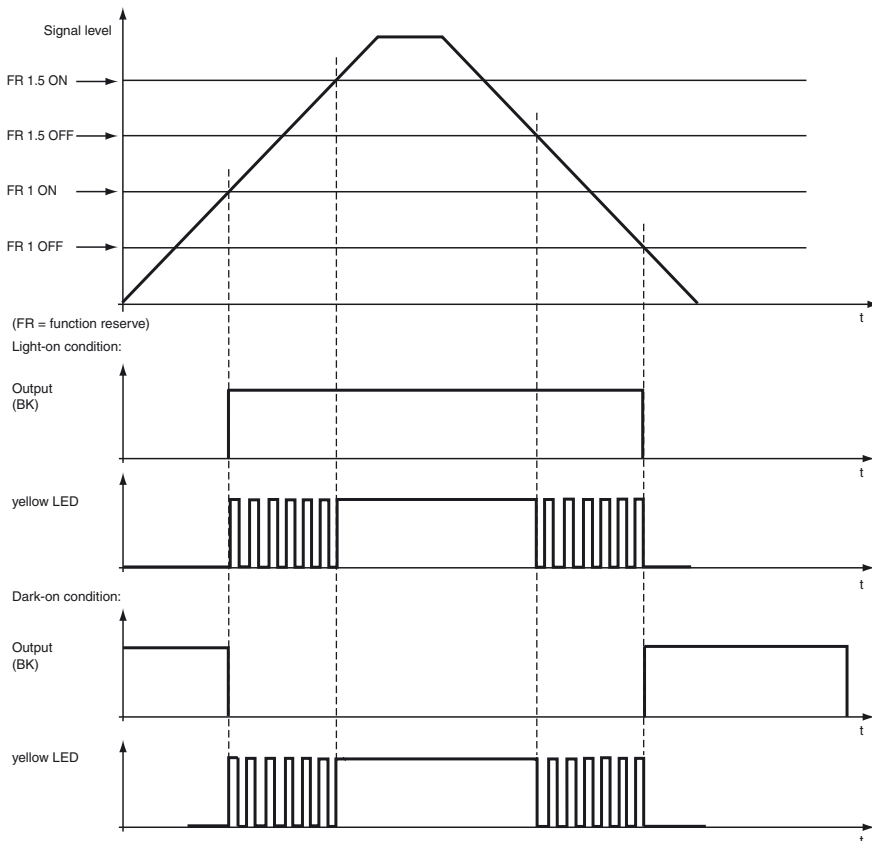

Release date: 2012-11-02 13:54 Date of issue: 2012-11-12 805075\_eng.xml

**Teach-In methods**

Subject to modifications without notice

Pepperl+Fuchs Group  
www.pepperl-fuchs.com

USA: +1 330 486 0001  
fa-info@us.pepperl-fuchs.com

Germany: +49 621 776-4411  
fa-info@pepperl-fuchs.com

Copyright Pepperl+Fuchs  
Singapore: +65 6779 9091  
fa-info@sg.pepperl-fuchs.com

**Maximum Teach-In**

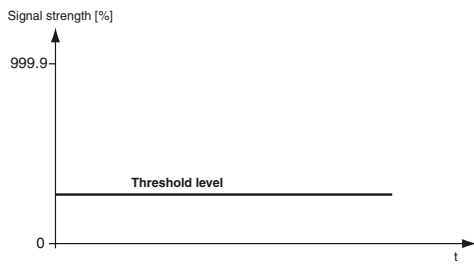

- Gain is set to maximum.
- Threshold is set to minimum.
- Maximum sensitivity is achieved.

**Position Teach-In**

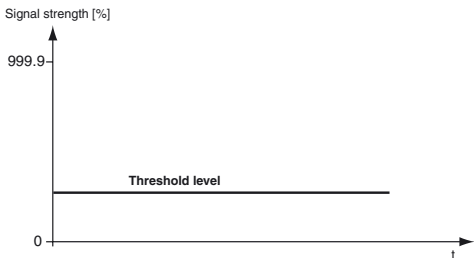

- Sensor set the optimum gain.
- Threshold is set to minimum.
- Signal received is ~ 100%.

**2-Point Teach-In**

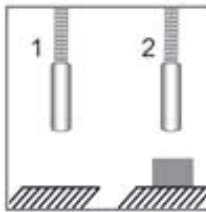
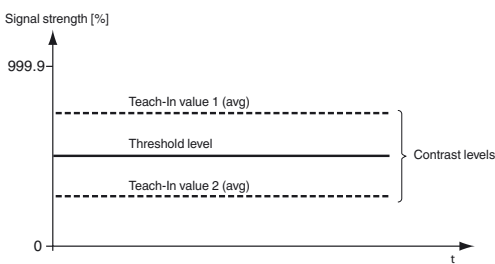

- Sensor set the optimum gain.
- Threshold is set in the middle of the 2 average taught values.

**Dynamic Teach-In**

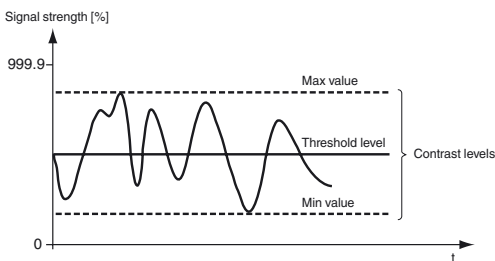

- Sensor set the optimum gain.
- Threshold is placed in the middle of the minimum and maximum taught values.

**Glass detection Teach-In**

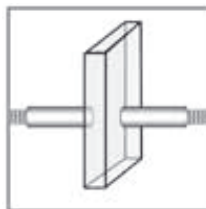
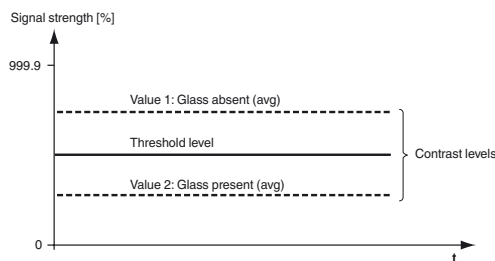

- Sensor set the optimum gain.
- Threshold is set in the middle of the 2 average taught values.

Release date: 2012-11-02 13:54 Date of issue: 2012-11-12 805075\_eng.xml

## Modular construction

Selection of the maximum number of connectible slave modules to a master module for cross-talk suppression via bridge contacts.

Number of linkable units	Operating modes			
	Standard	High Resolution	Auto	Glass detection
6u	6 modules	6 modules	6 modules	6 modules
12u	12 modules	12 modules	12 modules	12 modules
18u	18 modules	18 modules	18 modules	18 modules

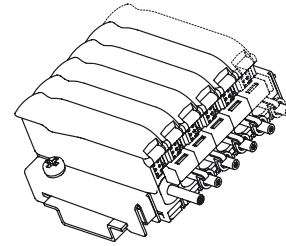

If 12u is selected, the switch-on delay doubles.

If 18u is selected, the switch-on delay triples.

When connecting several modules using bridge contacts, please ensure that the black blind pins on the bridge contacts are cut off. The outer blind pins must be retained only on the two outer bridge contacts. This is to seal off the pins that are not in use.

Master modules must **not** be connected to one another via the bridge contacts.

The power applied to the external input on the master module supplies the master module and all connected slave modules.

A master module is required to operate a slave module.

### Information regarding current consumption:

- Maximum of 20 units (19 slaves per master). Maximum current consumption = 20 mA per unit.
- Maximum of 10 units (9 slaves per master). Maximum current consumption = 70 mA per unit.
- Maximum of 8 units (7 slaves per master). Maximum current consumption = 110 mA per unit.

**Pay attention to the protective cover over the bridge contacts of the master modules**

**Menu structure**

The menu structure has three levels:

Level 0: Press the "mode"-button. Select the required function via the "±" -button.  
Press the "set"-button for confirmation.

Level 1: Select the required function via the "±" -button.  
Press the "set"-button to confirm your selection.

Level 2: Use the "±" - button to select the required time delay in 1ms steps.  
Press the "set"-button to confirm your selection.

To exit the menu, press the "mode"-button.

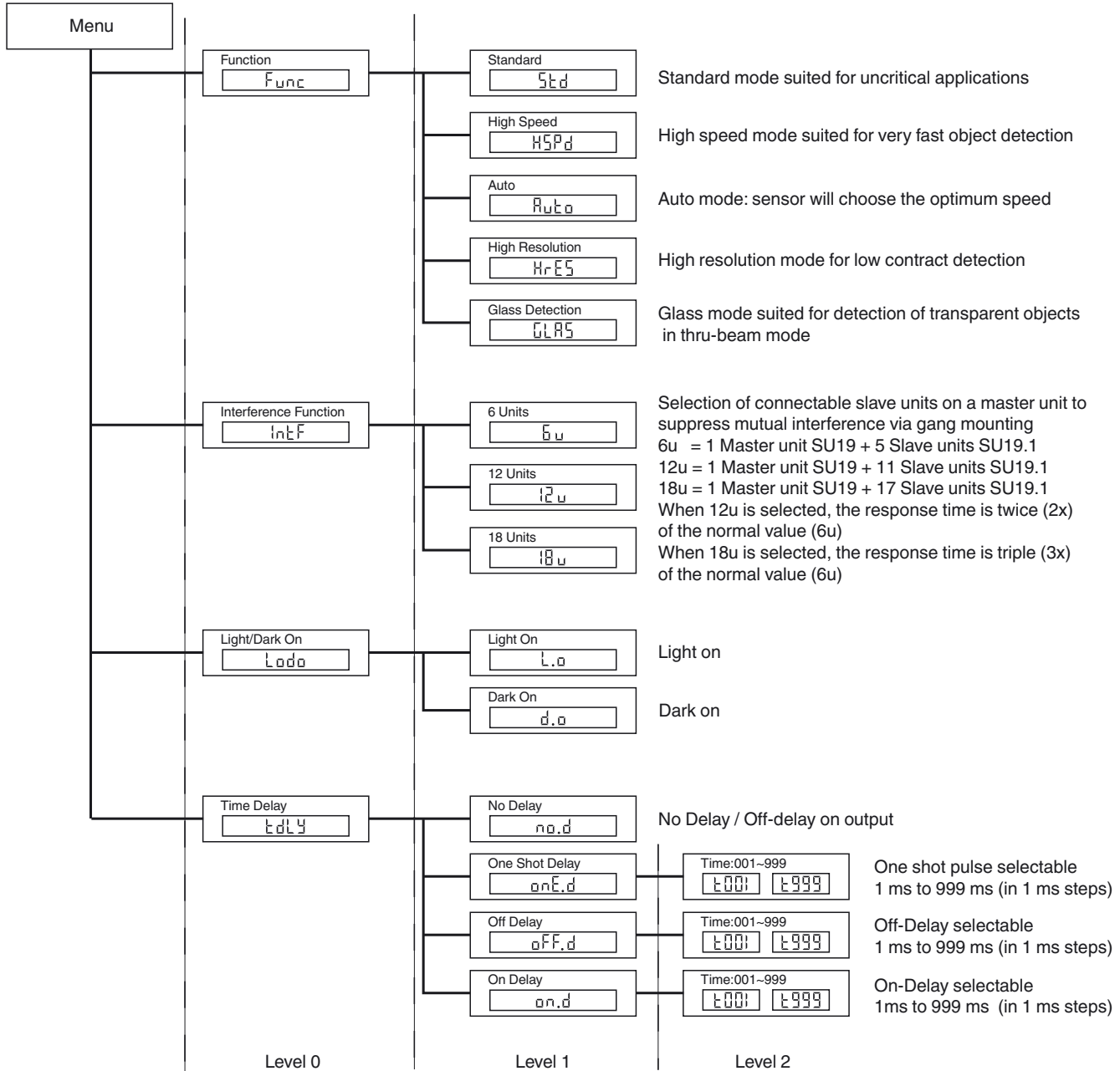

**Selection table - thru-beam fiber optic cable**

Head shape	Mounting	Model number	Core	Detection distance	Fiber cross section	minimum Object size	Fiber optic length	Bend radius	Dimensions	Special features
Highly precise										

Release date: 2012-11-02 13:54 Date of issue: 2012-11-12 805075\_eng.xml



Head shape	Mounting	Model number	Core	Detection distance	Fiber cross section	minimum Object size	Fiber optic length	Bend radius	Dimensions	Special features
Cylindrical	dia. 1.5 mm	KHE-C01-1.0-2.0-K139	PMMA	50 mm	0.5 mm	0.05 mm	2 m	min. 1 mm		only 1 mm Bend radius
Cylindrical	dia. 3 mm	KHE-C01-2.2-2.0-K126	PMMA	50 mm	0.5 mm	0.15 mm	2 m	min. 1 mm		only 1 mm Bend radius
Cylindrical	dia. 3 mm	KHE-C01-2.2-2.0-K123	PMMA	200 mm	1 mm	0.25 mm	2 m	min. 2 mm		only 2 mm Bend radius
Right angle	dia. 15 x 5	KHE-C01-2.2-2.0-K137	PMMA	35 mm	0.5 mm	0.15 mm	2 m	min. 1 mm		only 1 mm Bend radius
Right angle	dia. 15 x 5	KHE-C01-2.2-2.0-K140	PMMA	150 mm	1 mm	0.25 mm	2 m	min. 2 mm		only 2 mm Bend radius
<b>Flexible</b>										
Threaded	M3 x 0.5 /M2.6	KLE-C01-1.3-2.0-K112	PMMA	200 mm	1 mm	0.25 mm	2 m	min. 25 mm		4 x high Detection range with Auxiliary lens K-LA01/ 8 x high Detection range with Auxiliary lens K-LA06 Side view / Periscope with K-LA02
Threaded	M3 x 0.5	KLE-C01-2.2-2.0-K103	PMMA	220 mm	1 mm	0.25 mm	2 m	min. 25 mm		
Threaded	M4 x 0.7 /M2.6	KLE-C01-2.2-2.0-K102	PMMA	220 mm	1 mm	0.25 mm	2 m	min. 25 mm		4 x high Detection range with Auxiliary lens K-LA01/ 8 x high Detection range with Auxiliary lens K-LA06 Side view / Periscope with K-LA02
Threaded	M6	KLE-C01-2.2-2.0-K100	PMMA	220 mm	1 mm	0.32 mm	2 m	min. 25 mm		
Threaded	M2.6	KLE-C01-2.2-2.0-K113	PMMA	200 mm	1 mm	0.25 mm	2 m	min. 25 mm		4 x high Detection range with Auxiliary lens K-LA01/ 8 x high Detection range with Auxiliary lens K-LA06 Side view / Periscope with K-LA02
Cylindrical	dia. 2 mm	KLE-C01-1.3-2.0-K114	PMMA	220 mm	1 mm	0.25 mm	2 m	min. 25 mm		

Release date: 2012-11-02 13:54 Date of issue: 2012-11-12 805075\_eng.xml



Head shape	Mounting	Model number	Core	Detection distance	Fiber cross section	minimum Object size	Fiber optic length	Bend radius	Dimensions	Special features
Cylindrical	dia. 5 mm	KLE-C01-2.2-2.0-K101	PMMA	220 mm	1 mm	0.32 mm	2 m	min. 25 mm		
<b>Bendable tip</b>										
Threaded	M4	KLE 00-2.2-2.0-K55	PMMA	228 mm	1 mm		2 m	min. 25 mm		
<b>High detection range</b>										
Threaded	M3	KLE-C01-2.2-2.0-K116	PMMA	450 mm	1.5 mm	0.35 mm	2 m	min. 40 mm		
Threaded	M6	KLE-C01-2.2-2.0-K115	PMMA	450 mm	1.5 mm	0.35 mm	2 m	min. 40 mm		
Threaded	M8 x 1	FEF-PLT1	PMMA	6000 mm calculated value related on 2 m Fiber optic length	1 mm		1 m	min. 25 mm		Narrow beam
Threaded	M8 x 1	FEF-PLT1-L2	PMMA	6000 mm calculated value related on 2 m Fiber optic length	1 mm		2 m	min. 25 mm		Narrow beam
Threaded	M8 x 1	FEF-PLT1-L5	PMMA	6000 mm calculated value related on 2 m Fiber optic length	1 mm		4 m	min. 25 mm		Narrow beam
Cylindrical	dia. 3 mm	KLE-C01-2.2-2.0-K117	PMMA	400 mm	1.5 mm	0.35 mm	2 m	min. 25 mm		
<b>Side view / Periscope</b>										
Cylindrical	dia. 4.75 mm	KHE-C01-2.2-2.0-K136	PMMA	50 mm	0.5 mm	0.15 mm	2 m	min. 1 mm		only 1 mm Bend radius
Cylindrical	dia. 7 mm	KLE-C01-2.2-2.0-WC1	PMMA	120 mm	1,1 mm		2 m	min. 20 mm		
Right angle	M4	KHE-C01-2.2-2.0-K145	PMMA	112 mm			2 m	mind. 2 mm		
<b>Array</b>										

Release date: 2012-11-02 13:54 Date of issue: 2012-11-12 805075\_eng.xml

Subject to modifications without notice

Pepperl+Fuchs Group  
www.pepperl-fuchs.com

USA: +1 330 486 0001  
fa-info@us.pepperl-fuchs.com

Germany: +49 621 776-4411  
fa-info@pepperl-fuchs.com

Copyright Pepperl+Fuchs  
Singapore: +65 6779 9091  
fa-info@sg.pepperl-fuchs.com





Head shape	Mounting	Model number	Core	Detection distance	Fiber cross-section	Fiber optic length	Bend radius	Dimensions	Special features
Threaded	M4 x 0.7	KLR-C02-1.0-2.0-K73	PMMA	4 mm	2 x 0.25 mm	2 m	min. 10 mm		
Threaded	M3 x 0.5	KLR-C04-1.25-2.0-K78	PMMA	8 mm	4 x 0.25 mm	2 m	min. 15 mm		
Cylindrical	dia. 2.0 mm	KLR-C02-1.0-2.0-K91	PMMA	4 mm	2 x 0.25 mm	2 m	min. 10 mm		
Cylindrical	dia. 3.0 mm	KLR-C02-1.0-2.0-K90	PMMA	4 mm	2 x 0.25 mm	2 m	min. 10 mm		
Cylindrical	dia. 1.5 mm	KLR-C04-1.25-2.0-K80	PMMA	8 mm	4 x 0.25 mm	2 m	min. 15 mm		
Cylindrical	dia. 1.5 mm	KLR-C04-1.0-2.0-K133	PMMA	7 mm	4 x 0.25 mm	2 m	min. 15 mm		
Cylindrical	dia. 2.0 mm	KLR-C02-1.0-2.0-K87	PMMA	25 mm	2 x 0.5 mm	2 m	min. 15 mm		
Cylindrical	dia. 3.0 mm	KLR-C04-1.25-2.0-K79	PMMA	8 mm	4 x 0.25 mm	2 m	min. 15 mm		
<b>Coaxial</b>									
Threaded	M3 x 0.5	KLR-C09-1.25-2.0-K76	PMMA	30 mm	1 x 0.5 mm Emitter 9 x 0.25 mm Receiver	2 m	min. 15 mm		only 0.5 mm light spot at 8 mm with auxiliary lens K-LA03
Threaded	M4 x 0.7 /M2.6	KLR-C09-1.25-2.0-K74	PMMA	30 mm	1 x 0.5 mm Emitter 9 x 0.25 mm Receiver	2 m	min. 15 mm		only 0.7 mm light spot at 10 mm with auxiliary lens K-LA04/ 2 x high Detection range with Auxiliary lens K-LA01/ 3 x high Detection range with Auxiliary lens K-LA06
Threaded	M6 x 0.75	KLR-C16-2.2-2.0-K71	PMMA	85 mm	1 x 1.0 mm Emitter 16 x 0.25 mm Receiver	2 m	min. 25 mm		

Release date: 2012-11-02 13:54 Date of issue: 2012-11-12 805075\_eng.xml







