



CP18D2DNL2

Energetic diffusive sensor

CP18D2DNL2

with fixed cable



- ◆ Patented M18 plastic housing
- ◆ Short version: 55 mm
- ◆ Red LED for switching status
- ◆ Protection degree IP67



Release date: 2005-09-23 09:37 Date of issue: 2005-10-06 453143_ENG.xml

General specifications

Detection range	0 ... 200 mm
Light source	IRED 880 nm
Approvals	CE
USA	UL
Light type	infrared, modulated light
Angle of divergence	3 °
Optical face	frontal

Indicators/operating means

Function display	LED red
------------------	---------

Electrical specifications

Operating voltage	10 ... 30 V DC
Ripple	10 %
No-load supply current I_0	< 35 mA

Output

Switching type	light ON
Signal output	1 NPN output, short-circuit proof, protected from reverse polarity, open collector
Switching voltage	30 V DC
Switching current	max. 150 mA
Switching frequency f	500 Hz
Response time	1 ms

Standard conformity

Standards	EN 60947-5-2
-----------	--------------

Ambient conditions

Ambient temperature	-30 ... 70 °C (243 ... 343 K)
Storage temperature	-30 ... 70 °C (243 ... 343 K)

Mechanical specifications

Protection degree	IP67
Connection	Fixed cable 2 m
Material	
Housing	plastic
Optical face	plastic
Mass	60 g



CP18D2DNL2

Curves/Diagrams

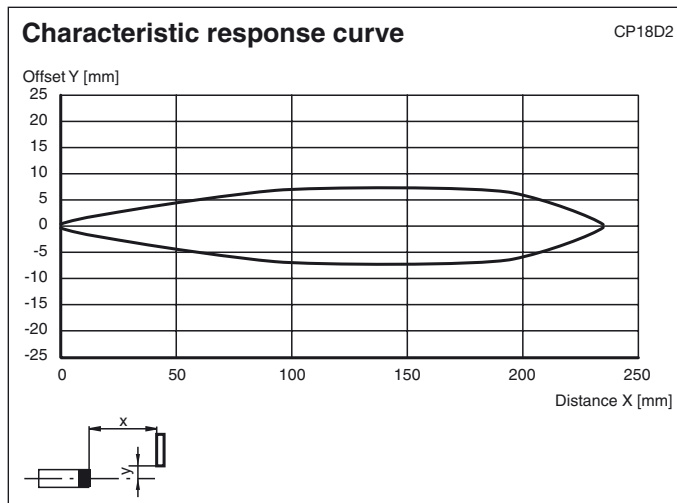
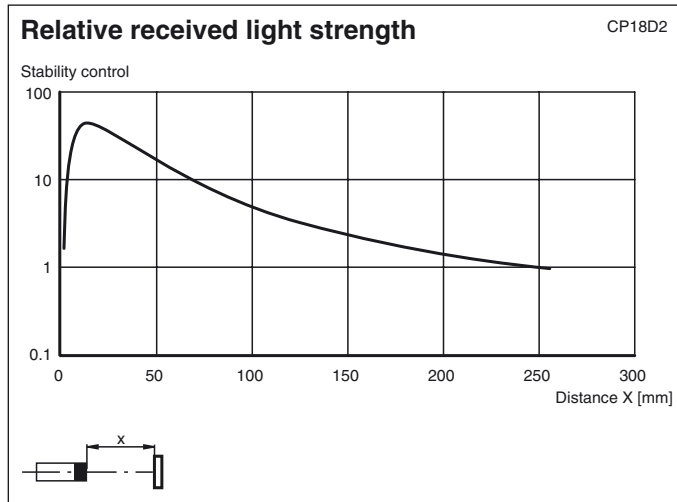

Dimensions

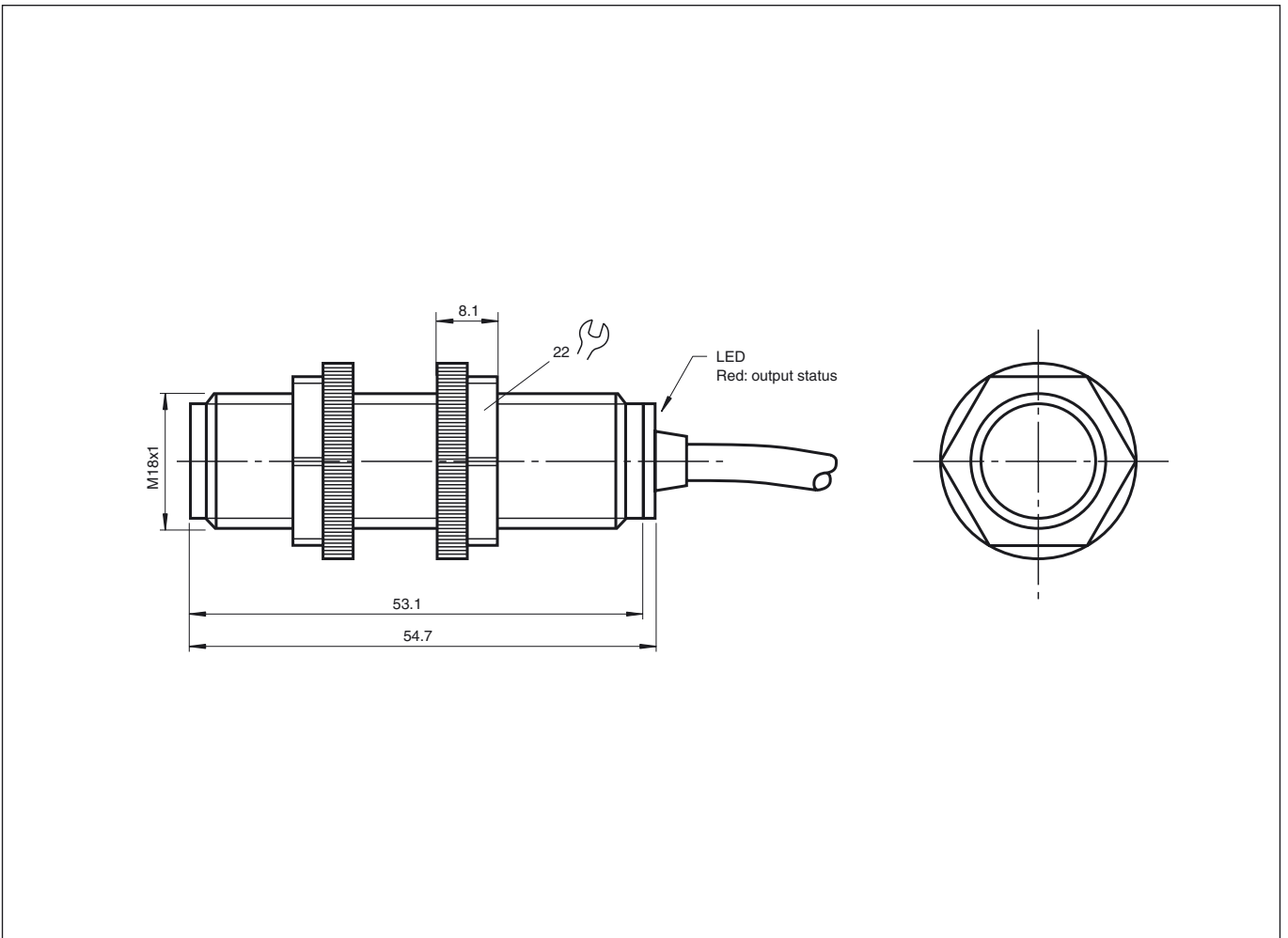

Electrical connection

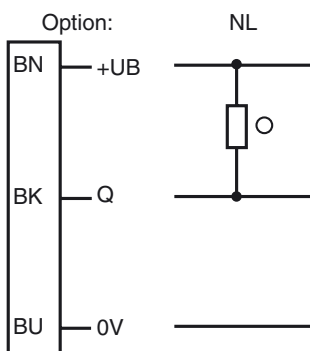

○ = light on, ● = dark on

Release date: 2005-09-23 09:37 Date of issue: 2005-10-06 453143_ENG.xml