

### Features

- Cast Aluminium
- Installation in Zone 1, Zone 2, Zone 21 and Zone 22
- Threaded cable entries
- Padlockable switch

### Dimensions (mm)

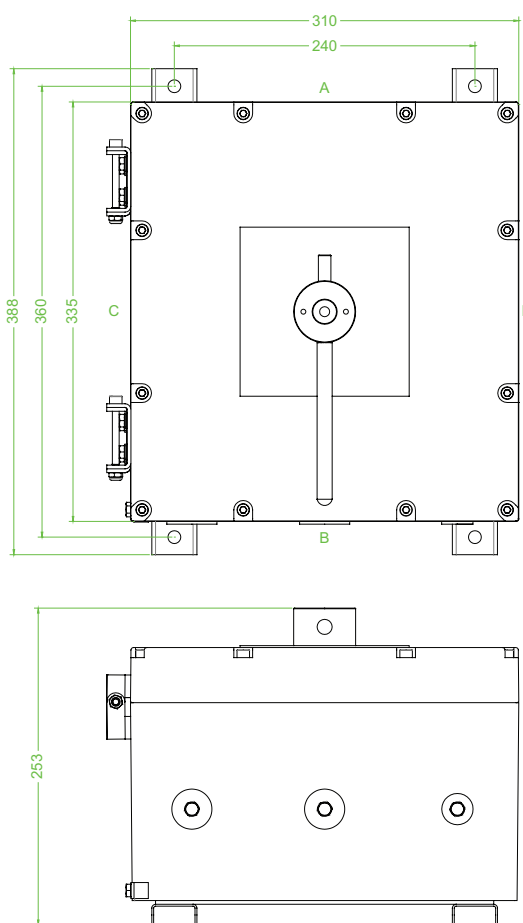

### Technical data

#### Electrical specifications

Operating voltage	690 V
Operating current	125 A (AC21A)
Power	45 kW (AC23A) 37 kW (AC3)
Terminal capacity	95 mm <sup>2</sup>
Function	switch disconnector
Number of poles	6
Auxiliary contacts	2 x n/o early break
Lockable	in 'OFF' position
Labeling	OFF - ON

#### Mechanical specifications

Height	335 mm NOM.
Width	310 mm NOM.
Depth	253 mm NOM.
Enclosure cover	hinged non-detachable
Cover fixing	M8 stainless steel socket cap head screws
Fastener grade	A2-70
Protection degree	IP66
Cable entry	metric threaded
Number of cable entries	2 x M32 in face B 1 x M20 in face B all entries are fitted with Ex d sealing plugs
Material	
Enclosure	cast aluminium
Finish	painted black
Seal	one piece closed cell neoprene
Mass	approx. 19 kg

Mounting	2 x fabricated stainless steel mounting straps
Grounding	internal & external brass grounding terminals on base and lid
<b>Ambient conditions</b>	
Ambient temperature	-40 ... 55 °C (-40 ... 131 °F)
<b>Data for application in connection with Ex-areas</b>	
EC-Type Examination Certificate	SIRA 04 ATEX 1266X
Group, category, type of protection, temperature class	⊕ II 2 GD Ex d IIB T5 Gb, Ex tb IIIC T82°C Db ( ta ... +55°C )
<b>International approvals</b>	
IECEX approval	IECEX SIR 08.0056X
GOST-R approval	GOST-R B01008
<b>Conformity</b>	
Protection degree	EN 60529
Switch	switch disconnecter to IEC 60947-3
<b>General information</b>	
Supplementary information	EC-Type Examination Certificate, Statement of Conformity, Declaration of Conformity, Attestation of Conformity and instructions have to be observed where applicable. For information see <a href="http://www.pepperl-fuchs.com">www.pepperl-fuchs.com</a> .