



Model Number

SLC-500-M

Safety light grid mirror

Features

- Deflecting mirror for multi-sided protection safety layouts using SLC series safety light grids

Dimensions

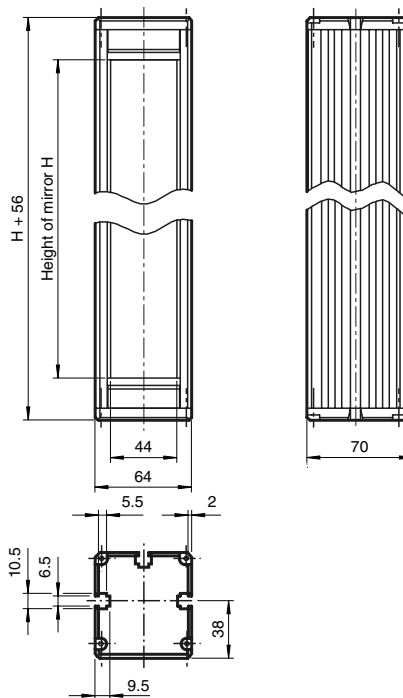

Technical data

Ambient conditions

Ambient temperature	-20 ... 60 °C (253 ... 333 K)
Storage temperature	-25 ... 70 °C (248 ... 343 K)

Mechanical specifications

Material	
Housing	Aluminium extruded rail profile , powder coated , RAL 1021 (yellow)

Suitable series

Safety Series	SLC
---------------	-----

Model Number

Order Code	Mirror height H	Housing length L
SLC-350-M	350 mm	406 mm
SLC-500-M	500 mm	556 mm
SLC-800-M	800 mm	856 mm
SLC-1000-M	1000 mm	1056 mm
SLC-1300-M	1300 mm	1356 mm
SLC-1600-M	1600 mm	1656 mm
SLC-1900-M	1900 mm	1956 mm
SLC-2400-M	2400 mm	2456 mm

Application:

The mirror is set, such that the light beam from the emitter is deflected to the receiver. In the case of a deflection of the protective field through 90° the mirror is set at an angle of 45°. When setting up the arrangement, care must be taken to ensure that all the components are aligned perpendicularly and at the same height. In order to provide a coarse alignment of the mirror, the mirror should be rotated such that the profile of the receiver can be seen in the mirror when viewed from the emitter towards the mirror. This alignment procedure is simplified by using the laser alignment tool BA SLP. Each mirror used reduces the range by about 15% max. Care should therefore also be taken to ensure that the mirror surfaces are clean. Only non-abrasive cleaning agents and lint-free cloth should be used for this purpose. Mounting sets are available for fixing purposes. Two such sets are required per mirror.

Attention should be paid to the information provided in the operating instructions applicable to the emitter and receiver in use. When making a periodic inspection of the arrangement, the protective field should be broken both before and after reflection on the mirror!