



MLV40-LL-IR/33/47

Sensor con fibra óptica para fibra óptica de vidrio

# MLV40-LL-IR/33/47

con 5 m de cable fijo



- ◆ Carcasa robusta de aluminio
- ◆ Adaptador de fibra óptica con cierre de tensión rápida
- ◆ Para espacios reducidos
- ◆ Extenso programa de fibra óptica como accesorio

**Generalidades**

Rango de detección	depende de la fibra óptica utilizada ver tabla de selección Fibras ópticas
Emisor de luz	IREL
Certificados	CE, cULus
Rango de ajuste	depende de la fibra óptica utilizada
Tipo de luz	Infrarrojo, luz alterna
Límite de luz extraña	50000 Lux

**Displays/Elementos de manejo**

Indicación de la función	LED amarillo, parpadea por debajo de la reserva de función
Elementos de mando	Regulador de sensibilidad

**Datos eléctricos**

Tensión de trabajo	10 ... 30 V CC
Rizado	10 %
Corriente en vacío $I_0$	40 mA

**Salida**

Tipo de conmutación	conmutación claro/oscuro
Salida señal	2 pnp, antivalente, prot. ctra. cortocircuito, prot. ctra. inversión de polaridad
Tensión de conmutación	máx. 30 V CC
Corriente de conmutación	máx. 200 mA
Frecuencia de conmutación f	100 Hz
Consumo de corriente	≤ 40 mA
Tiempo de respuesta	5 ms

**Conforme con estándar**

Estándar	EN 60947-5-2
----------	--------------

**Condiciones ambientales**

Temperatura ambiente	-20 ... 60 °C (253 ... 333 K)
Temperatura de almacenaje	-20 ... 75 °C (253 ... 348 K)

**Datos mecánicos**

Adaptador de fibra óptica (LWL)	04
Tipo de protección	IP65
Conexión	Cable fijo 5 m
Material	
Carcasa	aluminio
Salida de luz	Vidrio
Peso	100 g

Fecha de publicación: 2005-09-12 15:35 Fecha de edición: 2005-10-06 419660\_SPA.xml



## MLV40-LL-IR/33/47

Dimensiones

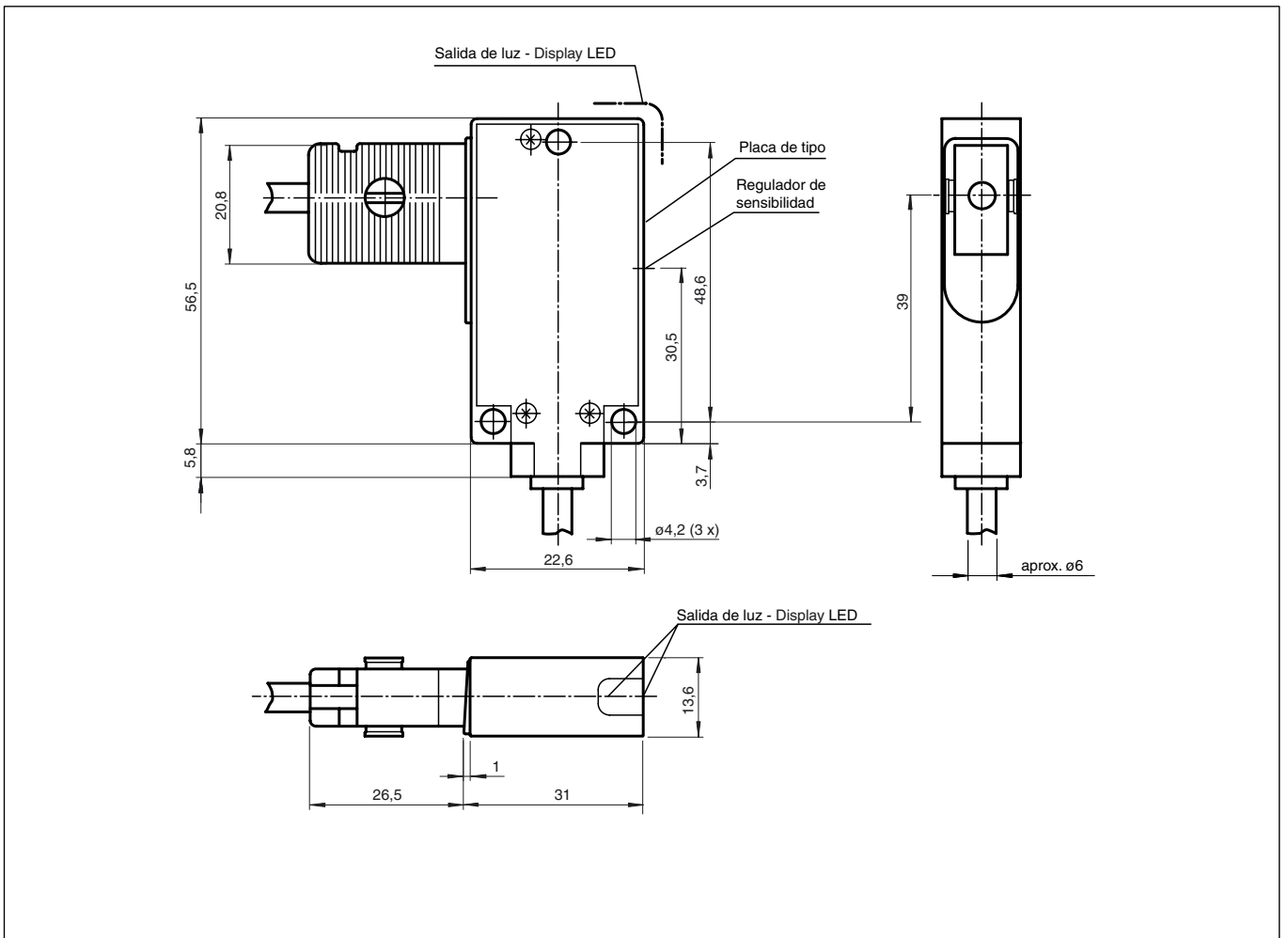

Conexión eléctrica

Fecha de publicación: 2005-09-12 15:35 Fecha de edición: 2005-10-06 419660\_SPA.xml

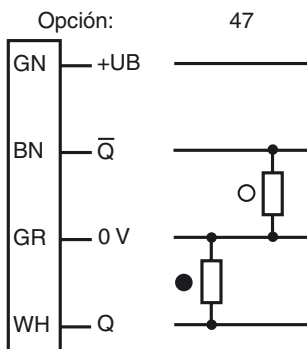

○ = conmutación claro, ● = conmutación oscuro

Tabla de selección de fibras ópticas

	Denominación	Alcance de detección en mm con			Figura
		MLV40-LL-IR	MLV40-LL-RT	SU14-LL	
Fibra óptica de vidrio barrera unidireccional con cubierta PVC	LCE04-1,1-0,5-WC3	100	50	100	1
	LCE04-1,1-1,5-WC3	110	60	80	1
	LCE04-1,6-0,5-WC3	280	80	160	2
	LCE04-1,6-1,0-WC3	200	60	120	2
	LCE04-1,6-1,0-Z1	280	80	160	3
	LCE04-1,6-1,0-G	280	80	160	4
Fibra óptica de vidrio de detección directa con cubierta PVC	LCR04-1,1-0,5-WC3	50	25	40	5
	LCR04-1,6-1,0-WC3	100	50	80	6
	LCR04-1,6-0,5-WC2	50	20	40	7
	LCR04-1,6-0,5-Z1	80	40	80	8
	LCR04-1,6-1,0-Z1	100	50	80	8
	LCR04-1,6-1,0-G	100	50	80	9
Fibra óptica de vidrio barrera unidireccional con cubierta de silicona - metal	LLE04-1,6-1,0-G	280	40	160	10
	LLE04-1,6-1,0-Z1	280	40	160	11
	LLE04-1,6-1,0-WC3	280	35	160	12
	LLE04-1,6-1,0-WC15	250	35	140	13
Fibra óptica de vidrio de detección directa con cubierta de silicona - metal	LLR04-1,6-0,5-G	90	40	80	14
	LLR04-1,6-1,0-G	100	50	80	14
	LLR04-1,6-0,5-QW1x4	80	35	60	18
	LLR04-1,6-1,0-QW1x4	60	40	40	18
	LLR04-1,6-0,5-WC3	80	35	60	15
	LLR04-1,6-1,0-WC3	100	50	80	15
	LLR04-1,9-1,0-WC5	100	50	70	16
	LLR04-1,6-1,0-Z1	110	50	80	17
Fibra óptica de vidrio barrera unidireccional con cubierta de metal	LME04-0,8-0,5-Z1	80	40	60	19
	LME04-0,8-1,0-Z1	60	30	40	19
	LME04-1,6-0,5-Z1	160	80	120	20
	LME04-1,9-0,5-Z1	200	100	150	20
	LME04-1,6-1,0-WC3	120	60	80	23
	LME04-0,8-0,5-WC4	70	35	45	21
	LME04-1,6-1,5-WC4	120	60	80	22
Fibra óptica de vidrio de detección directa con cubierta de metal	LMR04-0,5-0,5-WC4	6	5	5	24
	LMR04-0,5-0,5-Z0	7	6	5	26
	LMR04-0,5-0,5-Z1	7	6	5	25
	LMR04-1,6-0,5-Z1	80	35	60	27
	LMR04-1,9-0,5-Z1	90	40	70	28
	LMR04-0,6-0,5-QW0,25/2	5	3	4	29

Otras longitudes y cabezales de fibra bajo pedido



# MLV40-LL-IR/33/47

Adaptador

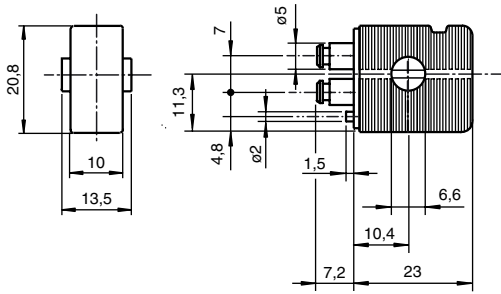

Función barrera unidireccional



Reflexión directa



Fig. 1

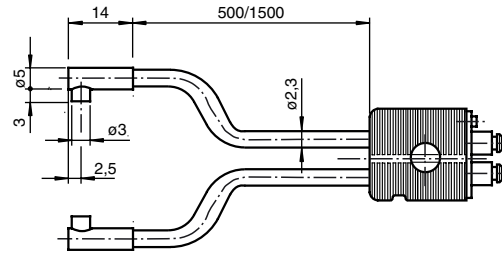

Fig. 2

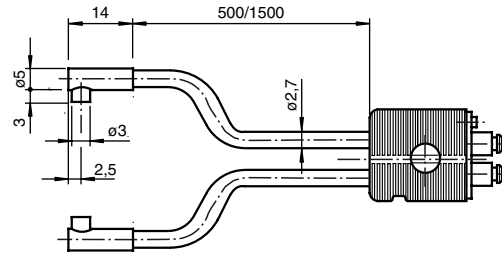

Fig. 3

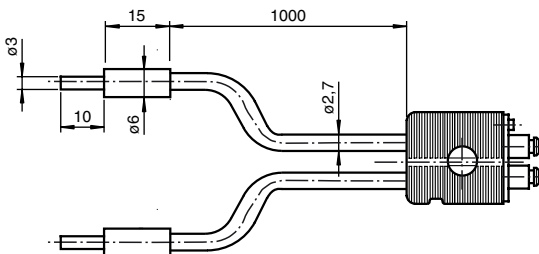

Fig. 4

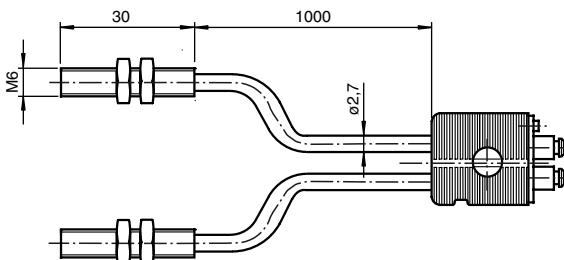

Fig. 5

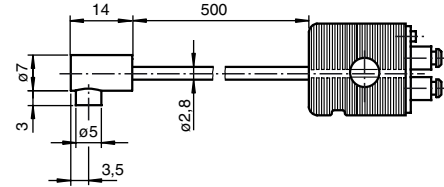

Fig. 6

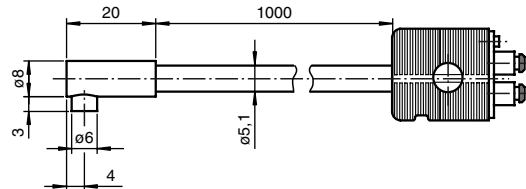

Fig. 7

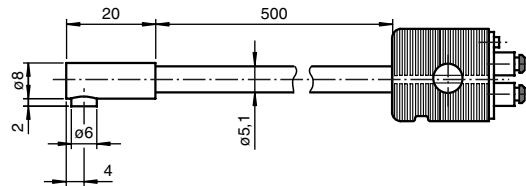

Fig. 8

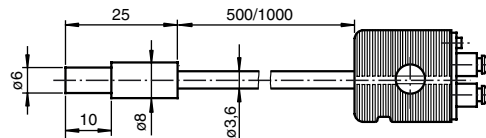

Fig. 9

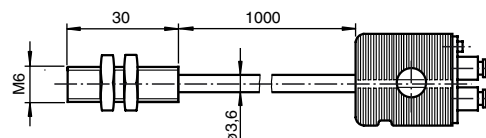





Fig. 10

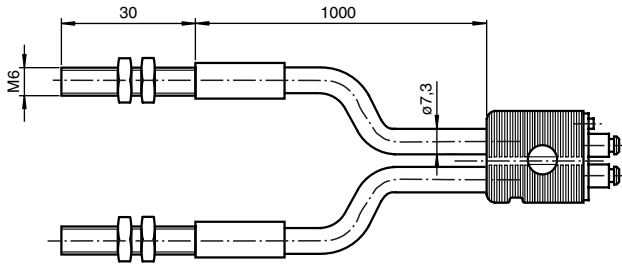

Fig. 11

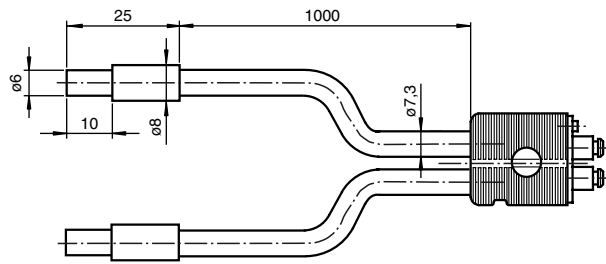

Fig. 12

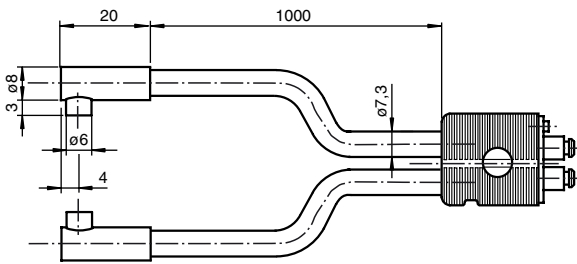

Fig. 13

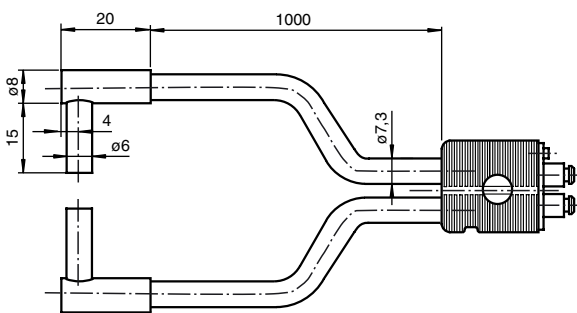

Fig. 14

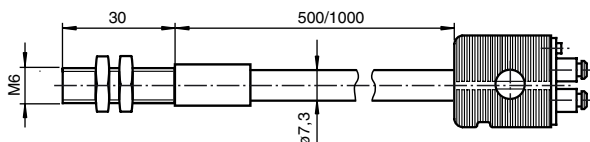

Fig. 15

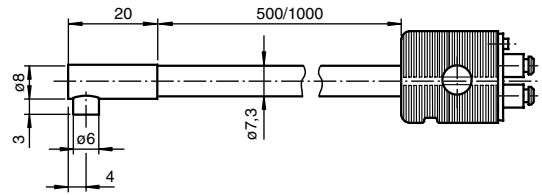

Fig. 16

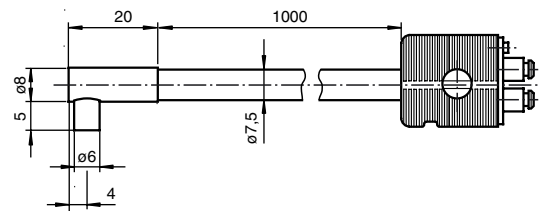

Fig. 17

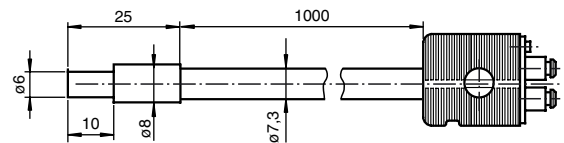

Fig. 18

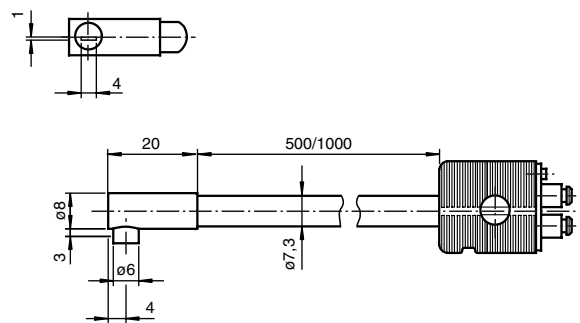

Fig. 19

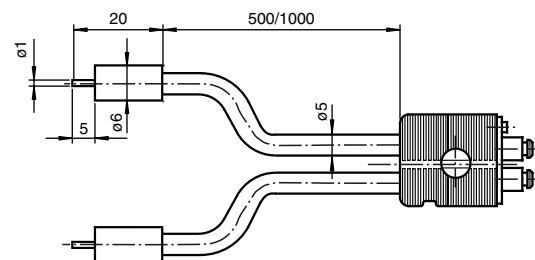



Fig. 20

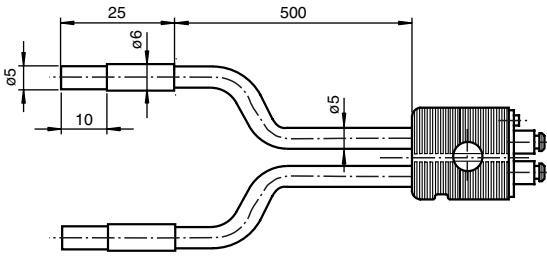

Fig. 25

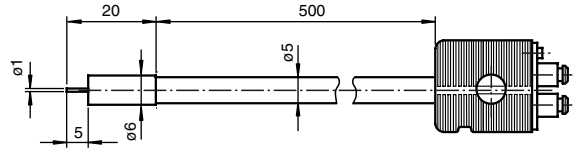

Fig. 21

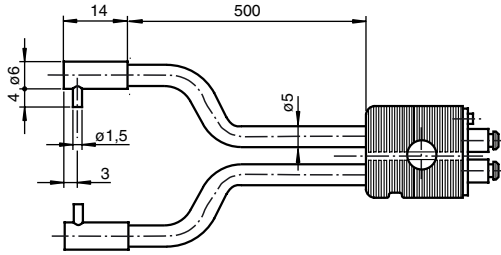

Fig. 26

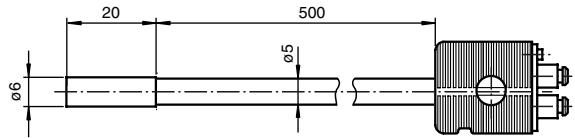

Fig. 22

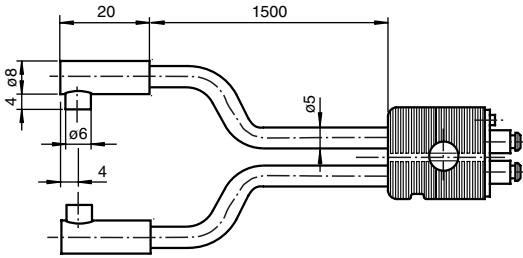

Fig. 27

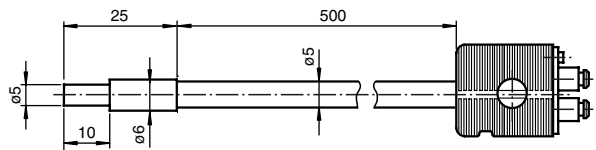

Fig. 23

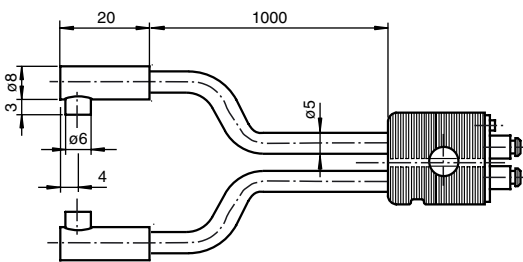

Fig. 28

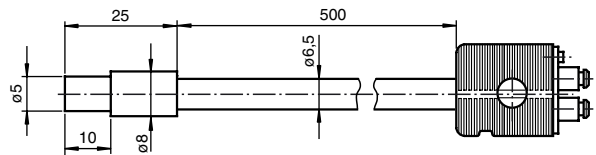

Fig. 24

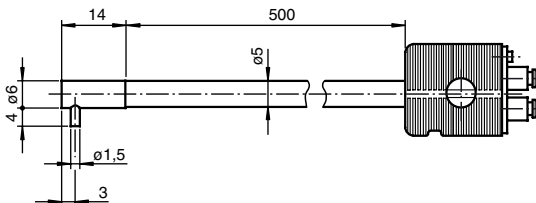
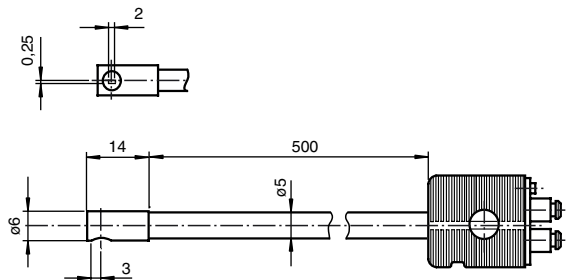

Fig. 29



Fecha de publicación: 2005-09-12 15:35 Fecha de edición: 2005-10-06 419660\_SPA.xml

