



MLV40-LL-IR/33/47

Fibre optic sensor for glass fibre optics

MLV40-LL-IR/33/47

with 5 m fixed cable



- ◆ Sturdy aluminium housing
- ◆ Fibre optic adapter with quick tightening shutter
- ◆ Less space required
- ◆ Extensive fibre optic product selection as accessories

General specifications

Detection range	depends on the fibre optics being used see selection table for fibre optics
Light source	IRED
Approvals	CE, cULus
Adjustment range	depends on the fibre optics being used
Light type	infrared, modulated light
Ambient light limit	50000 Lux

Indicators/operating means

Function display	LED yellow, flashes when falling short of the stability control
Operating elements	sensitivity adjuster

Electrical specifications

Operating voltage	10 ... 30 V DC
Ripple	10 %
No-load supply current I_0	40 mA

Output

Switching type	light/dark switching
Signal output	2 pnp, antivalent, short-circuit proof, protected against reverse polarity
Switching voltage	max. 30 V DC
Switching current	max. 200 mA
Switching frequency f	100 Hz
Current consumption	≤ 40 mA
Response time	5 ms

Standard conformity

Standards	EN 60947-5-2
-----------	--------------

Ambient conditions

Ambient temperature	-20 ... 60 °C (253 ... 333 K)
Storage temperature	-20 ... 75 °C (253 ... 348 K)

Mechanical specifications

LWL-Adapter	04
Protection degree	IP65
Connection	Fixed cable 5 m
Material	
Housing	aluminium
Optical face	glass
Mass	100 g

Release date: 2005-09-12 15:35 Date of issue: 2005-10-06 419660_ENG.xml



MLV40-LL-IR/33/47

Dimensions

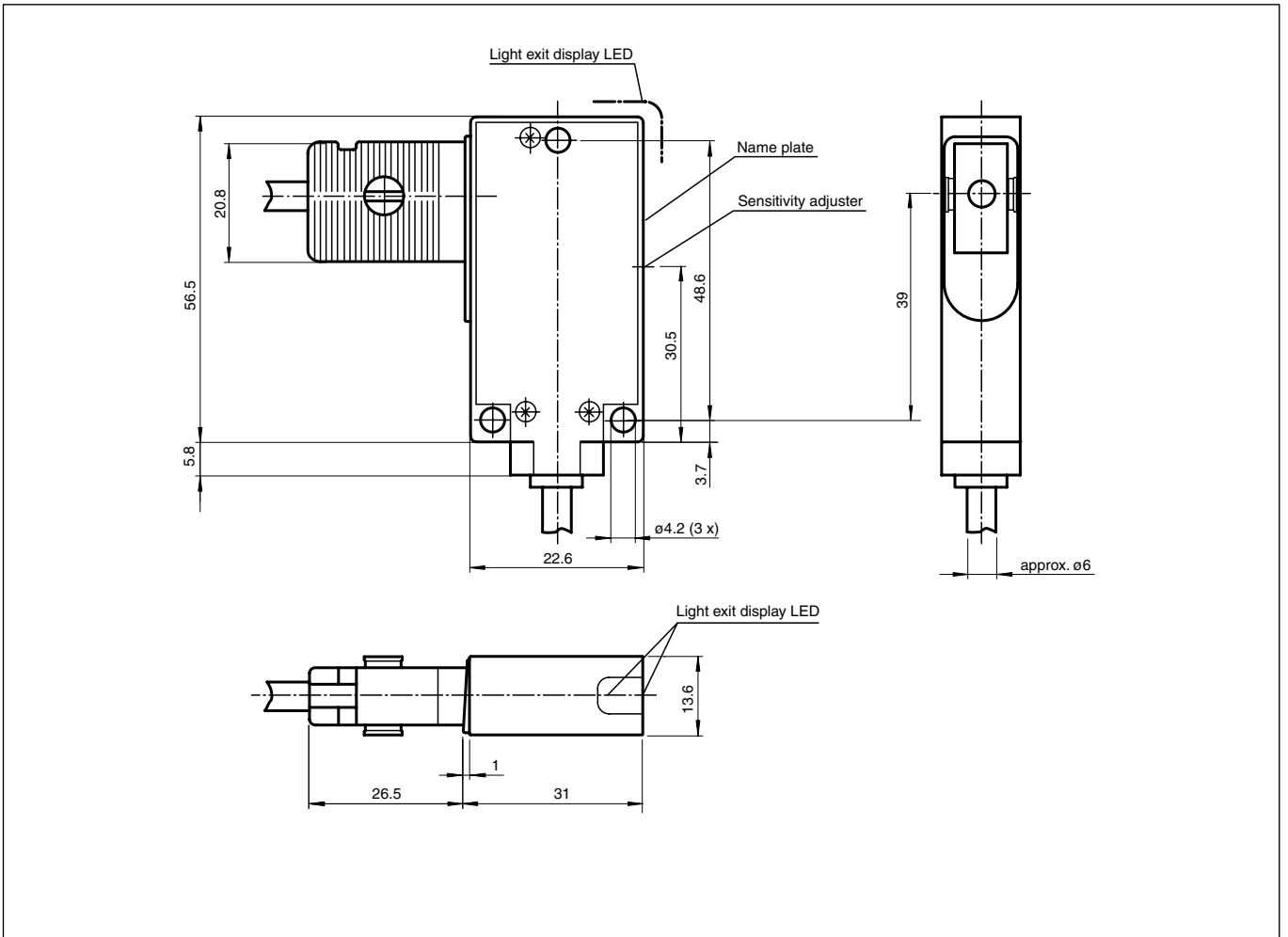

Electrical connection

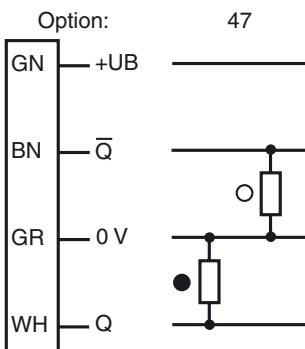

○ = light on, ● = dark on

Selection table for fibre

	Model number	Detection range in mm with			Figure
		MLV40-LL-IR	MLV40-LL-RT	SU14-LL	
Glass fibre optics single path with PVC coating	LCE04-1,1-0,5-WC3	100	50	100	1
	LCE04-1,1-1,5-WC3	110	60	80	1
	LCE04-1,6-0,5-WC3	280	80	160	2
	LCE04-1,6-1,0-WC3	200	60	120	2
	LCE04-1,6-1,0-Z1	280	80	160	3
	LCE04-1,6-1,0-G	280	80	160	4
Glass fibre optics reflex with PVC coating	LCR04-1,1-0,5-WC3	50	25	40	5
	LCR04-1,6-1,0-WC3	100	50	80	6
	LCR04-1,6-0,5-WC2	50	20	40	7
	LCR04-1,6-0,5-Z1	80	40	80	8
	LCR04-1,6-1,0-Z1	100	50	80	8
	LCR04-1,6-1,0-G	100	50	80	9
Glass fibre optics single path with metal- silicon coating	LLE04-1,6-1,0-G	280	40	160	10
	LLE04-1,6-1,0-Z1	280	40	160	11
	LLE04-1,6-1,0-WC3	280	35	160	12
	LLE04-1,6-1,0-WC15	250	35	140	13
Glass fibre optics reflex with metal-silicon coating	LLR04-1,6-0,5-G	90	40	80	14
	LLR04-1,6-1,0-G	100	50	80	14
	LLR04-1,6-0,5-QW1x4	80	35	60	18
	LLR04-1,6-1,0-QW1x4	60	40	40	18
	LLR04-1,6-0,5-WC3	80	35	60	15
	LLR04-1,6-1,0-WC3	100	50	80	15
	LLR04-1,9-1,0-WC5	100	50	70	16
	LLR04-1,6-1,0-Z1	110	50	80	17
Glass fibre optics single path with metal- coating	LME04-0,8-0,5-Z1	80	40	60	19
	LME04-0,8-1,0-Z1	60	30	40	19
	LME04-1,6-0,5-Z1	160	80	120	20
	LME04-1,9-0,5-Z1	200	100	150	20
	LME04-1,6-1,0-WC3	120	60	80	23
	LME04-0,8-0,5-WC4	70	35	45	21
	LME04-1,6-1,5-WC4	120	60	80	22
Glass fibre optics reflex with metal coating	LMR04-0,5-0,5-WC4	6	5	5	24
	LMR04-0,5-0,5-Z0	7	6	5	26
	LMR04-0,5-0,5-Z1	7	6	5	25
	LMR04-1,6-0,5-Z1	80	35	60	27
	LMR04-1,9-0,5-Z1	90	40	70	28
	LMR04-0,6-0,5-QW0,25/2	5	3	4	29

Other lengths and end pieces available on request

MLV40-LL-IR/33/47

Adapter

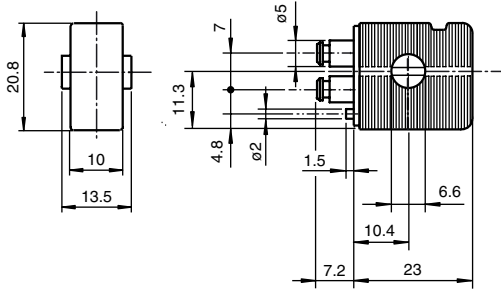

Single path

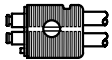

Reflex



Fig. 1

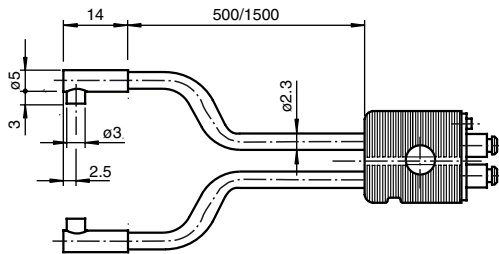

Fig. 2

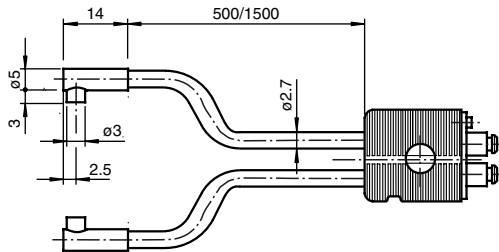

Fig. 3

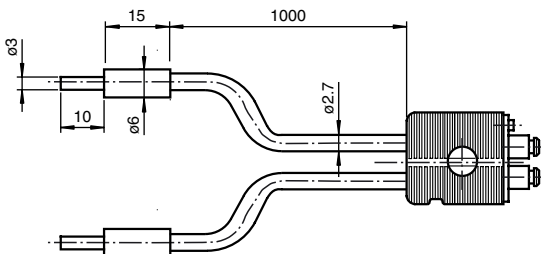

Fig. 4

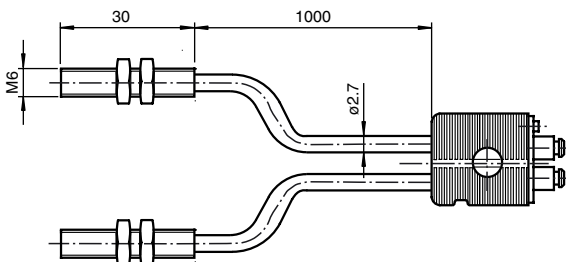

Fig. 5

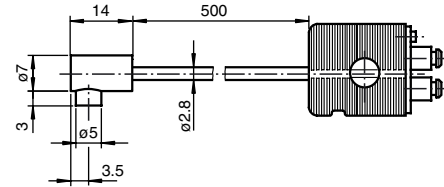

Fig. 6

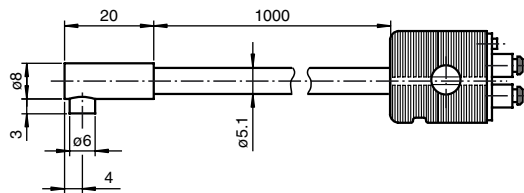

Fig. 7

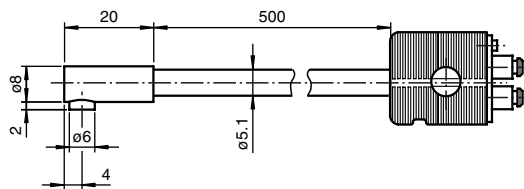

Fig. 8

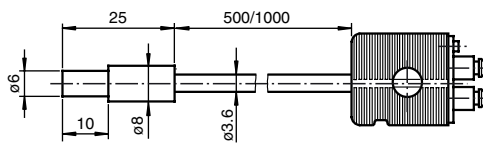
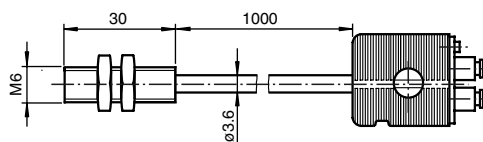

Fig. 9



Release date: 2005-09-12 15:35 Date of issue: 2005-10-06 419660_ENG.xml

MLV40-LL-IR/33/47

Fig. 10

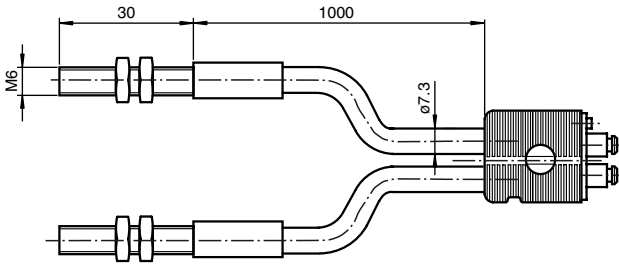

Fig. 11

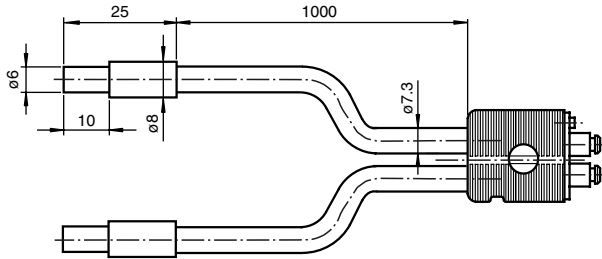

Fig. 12

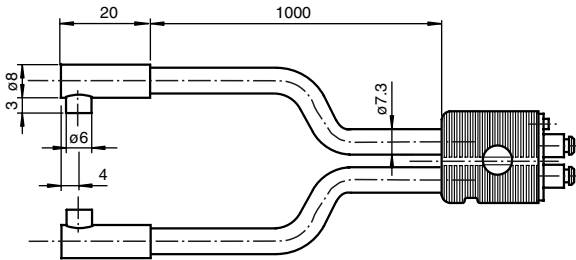

Fig. 13

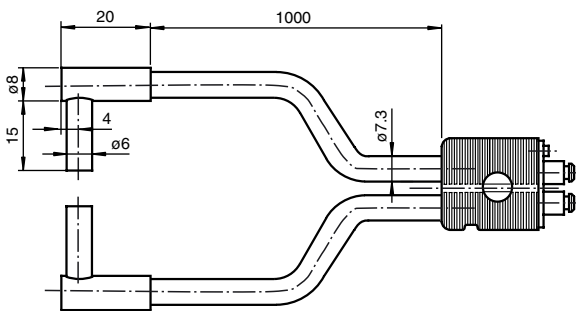

Fig. 14

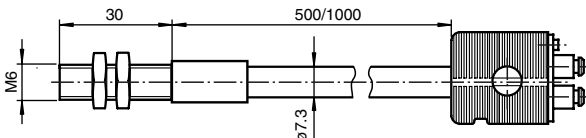

Fig. 15

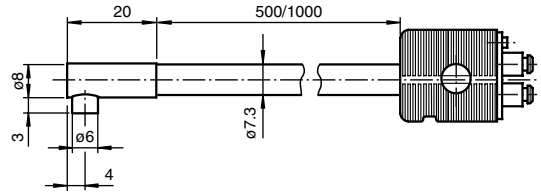

Fig. 16

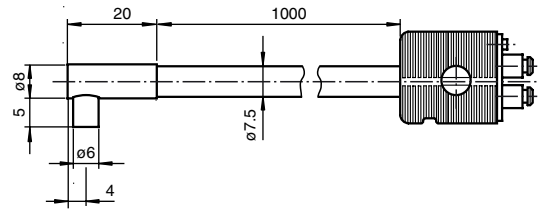

Fig. 17

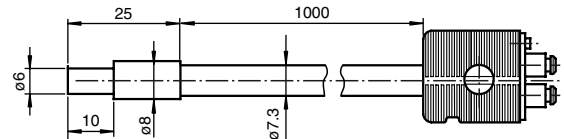

Fig. 18

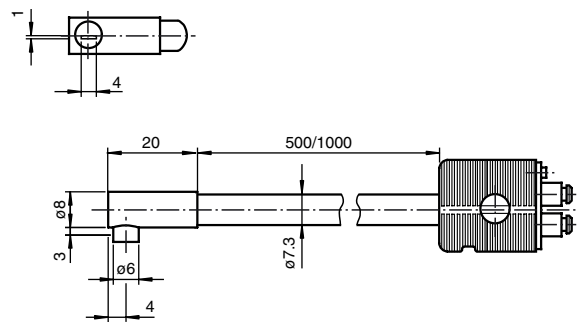
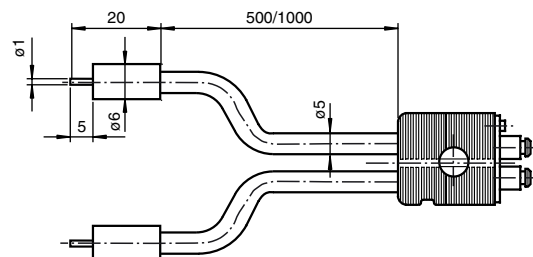

Fig. 19



Release date: 2005-09-12 15:35 Date of issue: 2005-10-06 419660_ENG.xml

Fig. 20

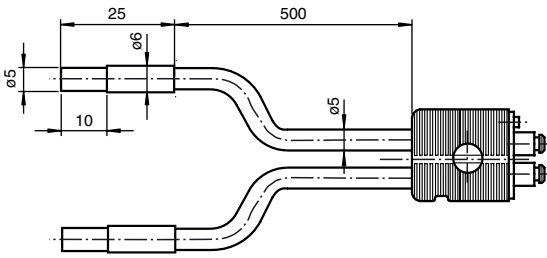

Fig. 25

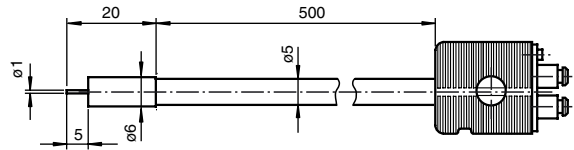

Fig. 21

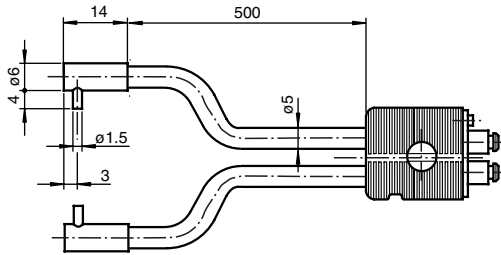

Fig. 26

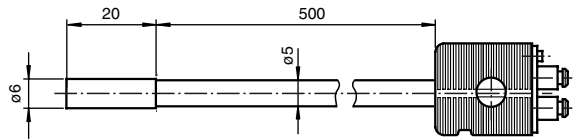

Fig. 22

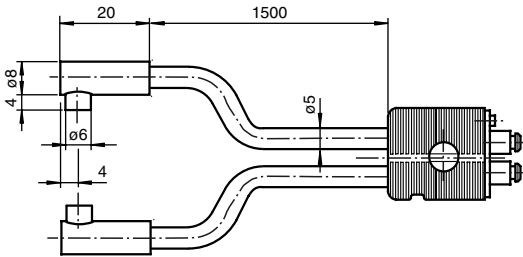

Fig. 27

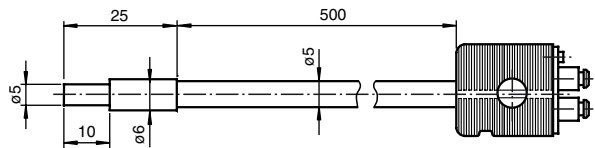

Fig. 23

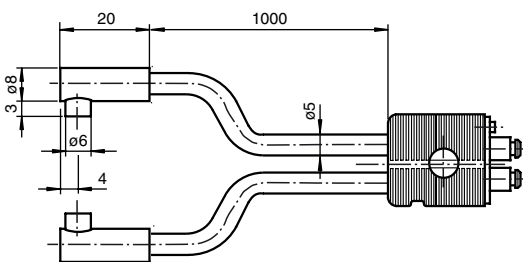

Fig. 28

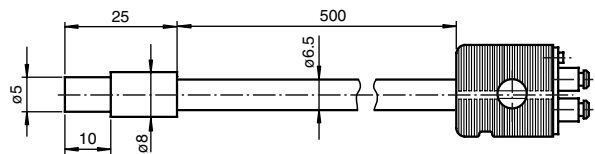

Fig. 24

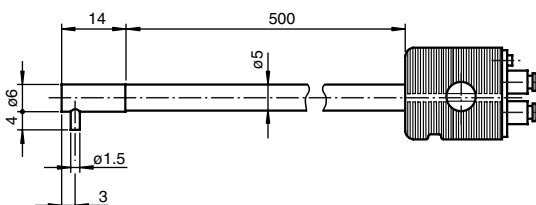
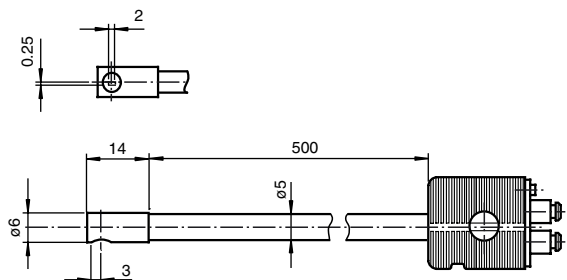

Fig. 29



Release date: 2005-09-12 15:35 Date of issue: 2005-10-06 419660_ENG.xml