



MLV40-LL-IR/49/115

Lichtleitergerät für Glasfaserlichtleiter

MLV40-LL-IR/49/115

mit 2 m Festkabel



- ◆ **Robustes Aluminiumgehäuse**
- ◆ **Lichtleiteradapter mit Schnellspannverschluss**
- ◆ **Geringer Platzbedarf**
- ◆ **Umfangreiches Lichtleiterprogramm als Zubehör**

Allgemeine Daten

Tastbereich	abhängig vom verwendeten Lichtleiter s. Auswahltabelle Lichtleiter
Lichtsender	IRED
Zulassungen	CE, cULus
Einstellbereich	abhängig vom verwendeten Lichtleiter
Lichtart	infrarot, Wechsellicht
Fremdlichtgrenze	50000 Lux

Anzeigen/Bedienelemente

Funktionsanzeige	LED gelb, blinkt bei Unterschreiten der Funktionsreserve
Bedienelemente	Empfindlichkeitseinsteller

Elektrische Daten

Betriebsspannung	10 ... 30 V DC
Welligkeit	10 %
Leerlaufstrom I_0	40 mA

Ausgang

Schaltungsart	dunkelschaltend
Signalausgang	1 pnp und 1 npn, kurzschlussfest, verpolgeschützt
Schaltspannung	max. 30 V DC
Schaltstrom	max. 200 mA
Schaltfrequenz f	100 Hz
Stromaufnahme	≤ 40 mA
Ansprechzeit	5 ms

Normenkonformität

Normen	EN 60947-5-2
--------	--------------

Umgebungsbedingungen

Umgebungstemperatur	-20 ... 60 °C (253 ... 333 K)
Lagertemperatur	-20 ... 75 °C (253 ... 348 K)

Mechanische Daten

LWL-Adapter	04
Schutzart	IP65
Anschluss	Festkabel 2 m
Material	
Gehäuse	Aluminium
Lichtaustritt	Glas
Masse	100 g



MLV40-LL-IR/49/115

Abmessungen

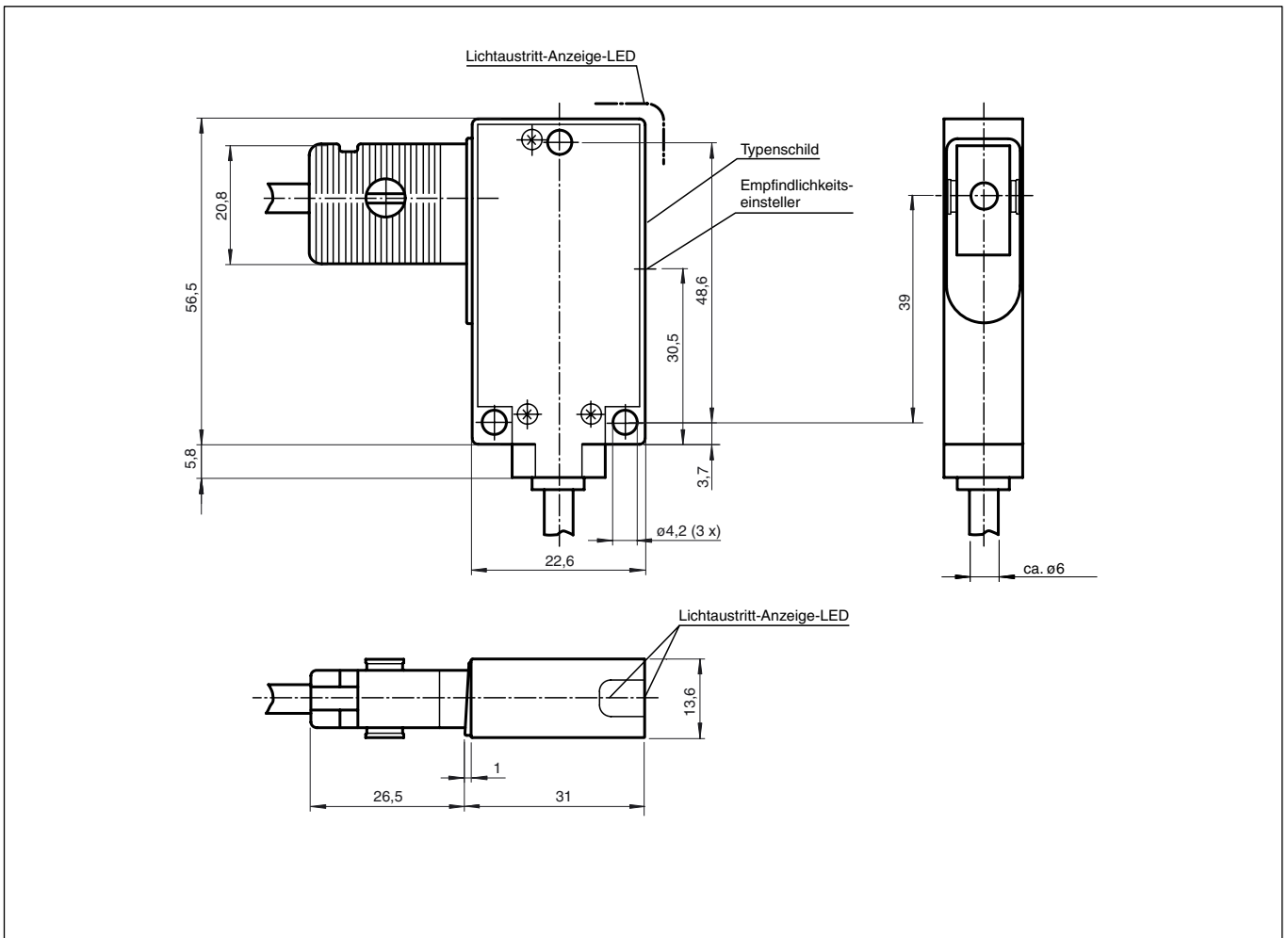

Elektrischer Anschluß

Veröffentlichungsdatum: 2005-09-12 14:59 Ausgabedatum: 2005-09-12 419655_GER.xml

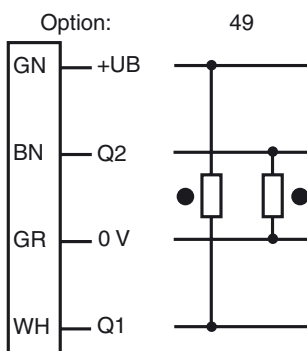

○ = Hellschaltung, ● = Dunkelschaltung

Auswahltabelle Lichtleiter

	Bezeichnung	Tastweite in mm mit			Abbildung
		MLV40-LL-IR	MLV40-LL-RT	SU14-LL	
Glasfaserlichtleiter - Einweg mit PVC-Ummantelung	LCE04-1,1-0,5-WC3	100	50	100	1
	LCE04-1,1-1,5-WC3	110	60	80	1
	LCE04-1,6-0,5-WC3	280	80	160	2
	LCE04-1,6-1,0-WC3	200	60	120	2
	LCE04-1,6-1,0-Z1	280	80	160	3
	LCE04-1,6-1,0-G	280	80	160	4
Glasfaserlichtleiter - Reflex mit PVC-Ummantelung	LCR04-1,1-0,5-WC3	50	25	40	5
	LCR04-1,6-1,0-WC3	100	50	80	6
	LCR04-1,6-0,5-WC2	50	20	40	7
	LCR04-1,6-0,5-Z1	80	40	80	8
	LCR04-1,6-1,0-Z1	100	50	80	8
	LCR04-1,6-1,0-G	100	50	80	9
Glasfaserlichtleiter - Einweg mit Metall-Silikon-Ummantelung	LLE04-1,6-1,0-G	280	40	160	10
	LLE04-1,6-1,0-Z1	280	40	160	11
	LLE04-1,6-1,0-WC3	280	35	160	12
	LLE04-1,6-1,0-WC15	250	35	140	13
Glasfaserlichtleiter- Reflex mit Metall-Silikon-Ummantelung	LLR04-1,6-0,5-G	90	40	80	14
	LLR04-1,6-1,0-G	100	50	80	14
	LLR04-1,6-0,5-QW1x4	80	35	60	18
	LLR04-1,6-1,0-QW1x4	60	40	40	18
	LLR04-1,6-0,5-WC3	80	35	60	15
	LLR04-1,6-1,0-WC3	100	50	80	15
	LLR04-1,9-1,0-WC5	100	50	70	16
	LLR04-1,6-1,0-Z1	110	50	80	17
Glasfaserlichtleiter - Einweg mit Metall-Ummantelung	LME04-0,8-0,5-Z1	80	40	60	19
	LME04-0,8-1,0-Z1	60	30	40	19
	LME04-1,6-0,5-Z1	160	80	120	20
	LME04-1,9-0,5-Z1	200	100	150	20
	LME04-1,6-1,0-WC3	120	60	80	23
	LME04-0,8-0,5-WC4	70	35	45	21
	LME04-1,6-1,5-WC4	120	60	80	22
Glasfaserlichtleiter - Reflex mit Metall-Ummantelung	LMR04-0,5-0,5-WC4	6	5	5	24
	LMR04-0,5-0,5-Z0	7	6	5	26
	LMR04-0,5-0,5-Z1	7	6	5	25
	LMR04-1,6-0,5-Z1	80	35	60	27
	LMR04-1,9-0,5-Z1	90	40	70	28
	LMR04-0,6-0,5-QW0,25/2	5	3	4	29

Andere Längen und Endstücke auf Anfrage

Veröffentlichungsdatum: 2005-09-12 14:59 Ausgabedatum: 2005-09-12 419655_GER.xml

MLV40-LL-IR/49/115

Adapter

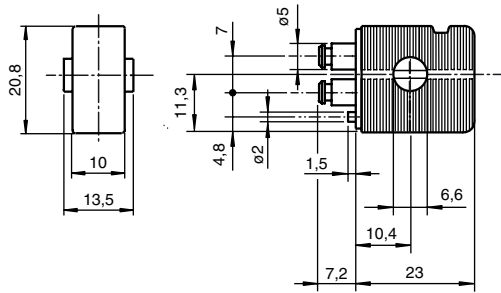

Einweg

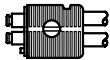

Reflex



Abb. 1



Abb. 2



Abb. 3

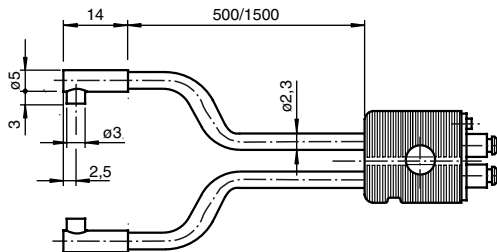

Abb. 4

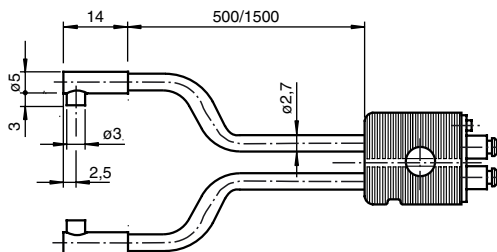

Abb. 5

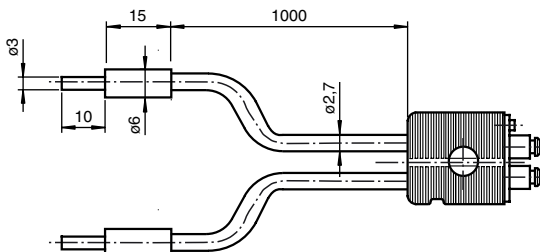

Abb. 6

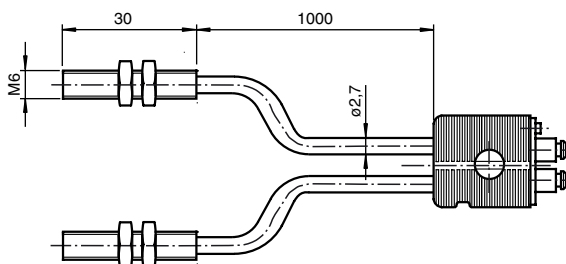

Abb. 7

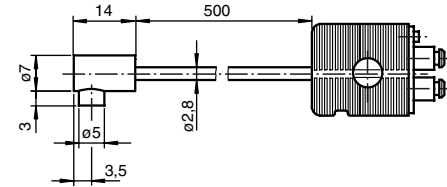

Abb. 8

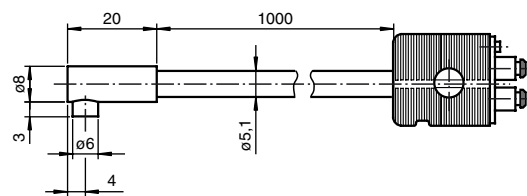

Abb. 9

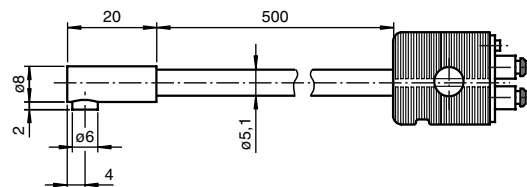

Veröffentlichungsdatum: 2005-09-12 14:59 Ausgabedatum: 2005-09-12 419655_GER.xml

MLV40-LL-IR/49/115

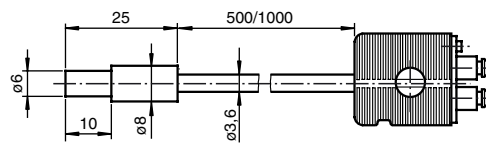
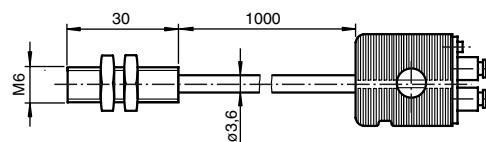
Abb. 10



Abb. 15



Abb. 11

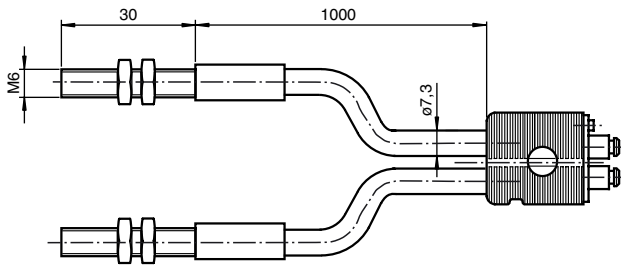

Abb. 16

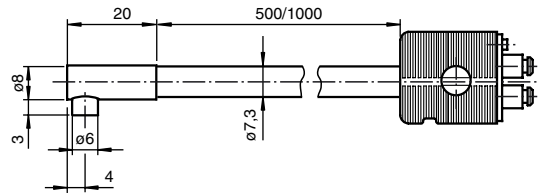

Abb. 12

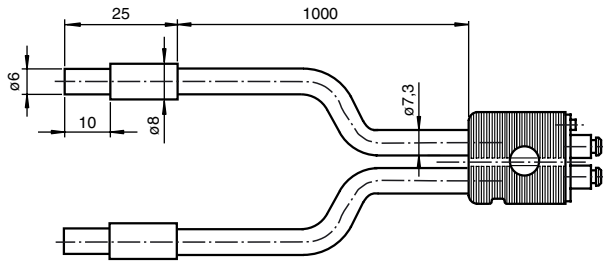

Abb. 17

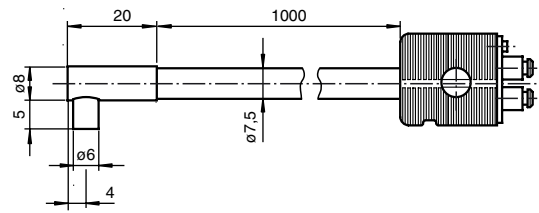

Abb. 13

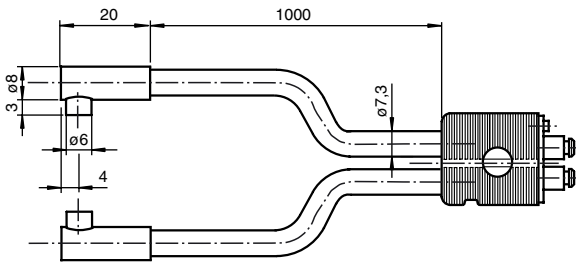

Abb. 18

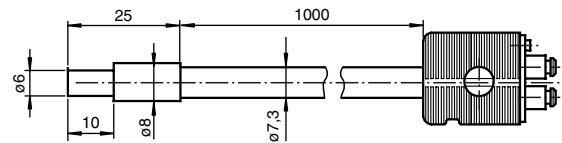

Abb. 14

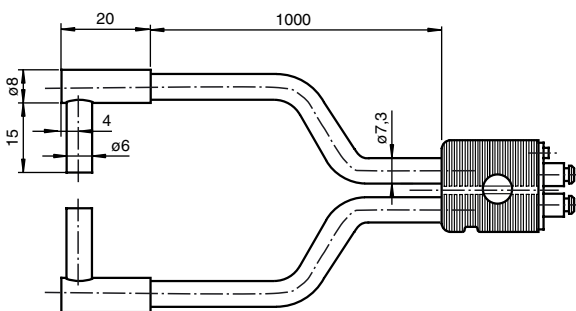

Abb. 19

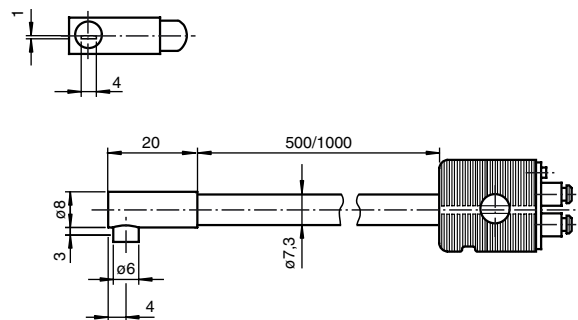

Abb. 20

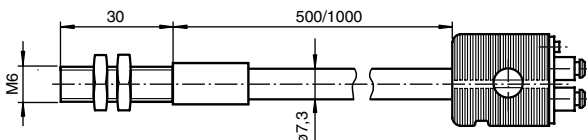

Abb. 25

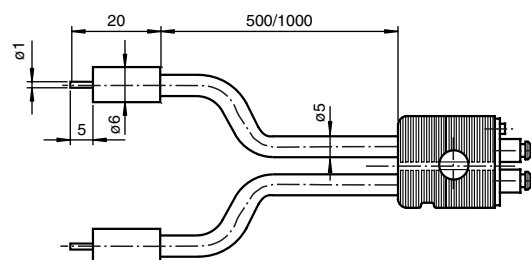

Abb. 21

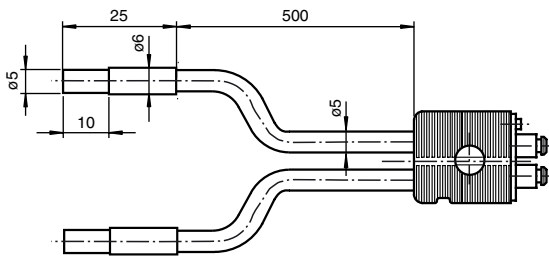

Abb. 26

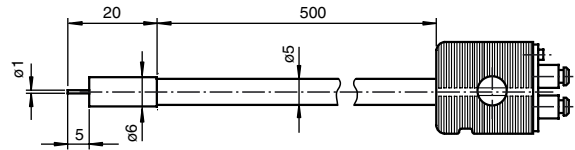

Abb. 22

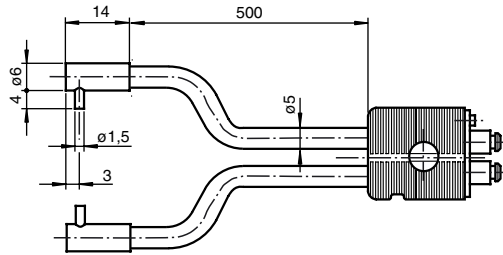

Abb. 27

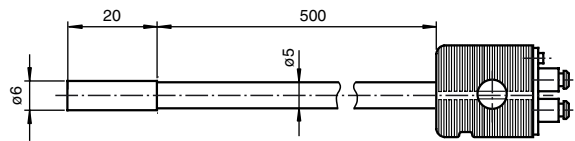

Abb. 23

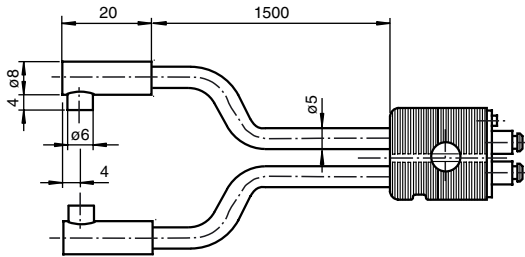

Abb. 28

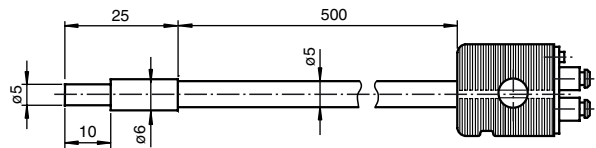

Abb. 24

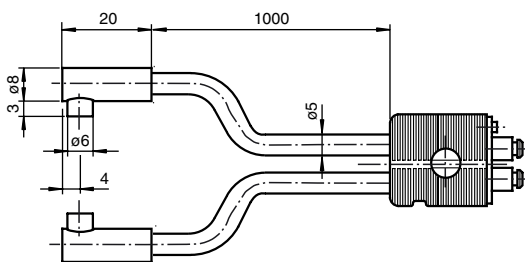

Abb. 29

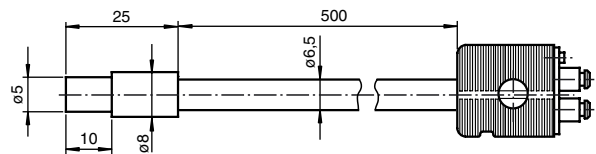
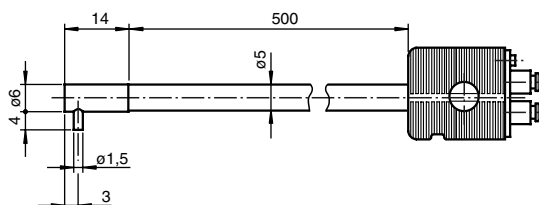