



MLV40-LL-RT/48/115

Lichtleitergerät für Glasfaserlichtleiter

# MLV40-LL-RT/48/115

mit 2 m Festkabel



- ◆ **Robustes Aluminiumgehäuse**
- ◆ **Lichtleiteradapter mit Schnellspannverschluss**
- ◆ **Geringer Platzbedarf**
- ◆ **Umfangreiches Lichtleiterprogramm als Zubehör**

**Allgemeine Daten**

Tastbereich	abhängig vom verwendeten Lichtleiter s. Auswahltabelle Lichtleiter
Lichtsender	LED, Rotlicht
Zulassungen	CE, cULus
Einstellbereich	abhängig vom verwendeten Lichtleiter
Lichtart	rot, Wechsellicht
Fremdlichtgrenze	50000 Lux

**Anzeigen/Bedienelemente**

Funktionsanzeige	LED gelb, blinkt bei Unterschreiten der Funktionsreserve
Bedienelemente	Empfindlichkeitseinsteller

**Elektrische Daten**

Betriebsspannung	10 ... 30 V DC
Welligkeit	10 %
Leerlaufstrom $I_0$	40 mA

**Ausgang**

Schaltungsart	hell-/dunkelschaltend
Signalausgang	2 npn antivalent, kurzschlussfest, verpolgeschützt
Schaltspannung	max. 30 V DC
Schaltstrom	max. 200 mA
Schaltfrequenz $f$	100 Hz
Stromaufnahme	$\leq 40$ mA
Ansprechzeit	5 ms

**Normenkonformität**

Normen	EN 60947-5-2
--------	--------------

**Umgebungsbedingungen**

Umgebungstemperatur	-20 ... 60 °C (253 ... 333 K)
Lagertemperatur	-20 ... 75 °C (253 ... 348 K)

**Mechanische Daten**

LWL-Adapter	04
Schutzart	IP65
Anschluss	Festkabel 2 m
Material	
Gehäuse	Aluminium
Lichtaustritt	Glas
Masse	100 g



**MLV40-LL-RT/48/115**

Abmessungen

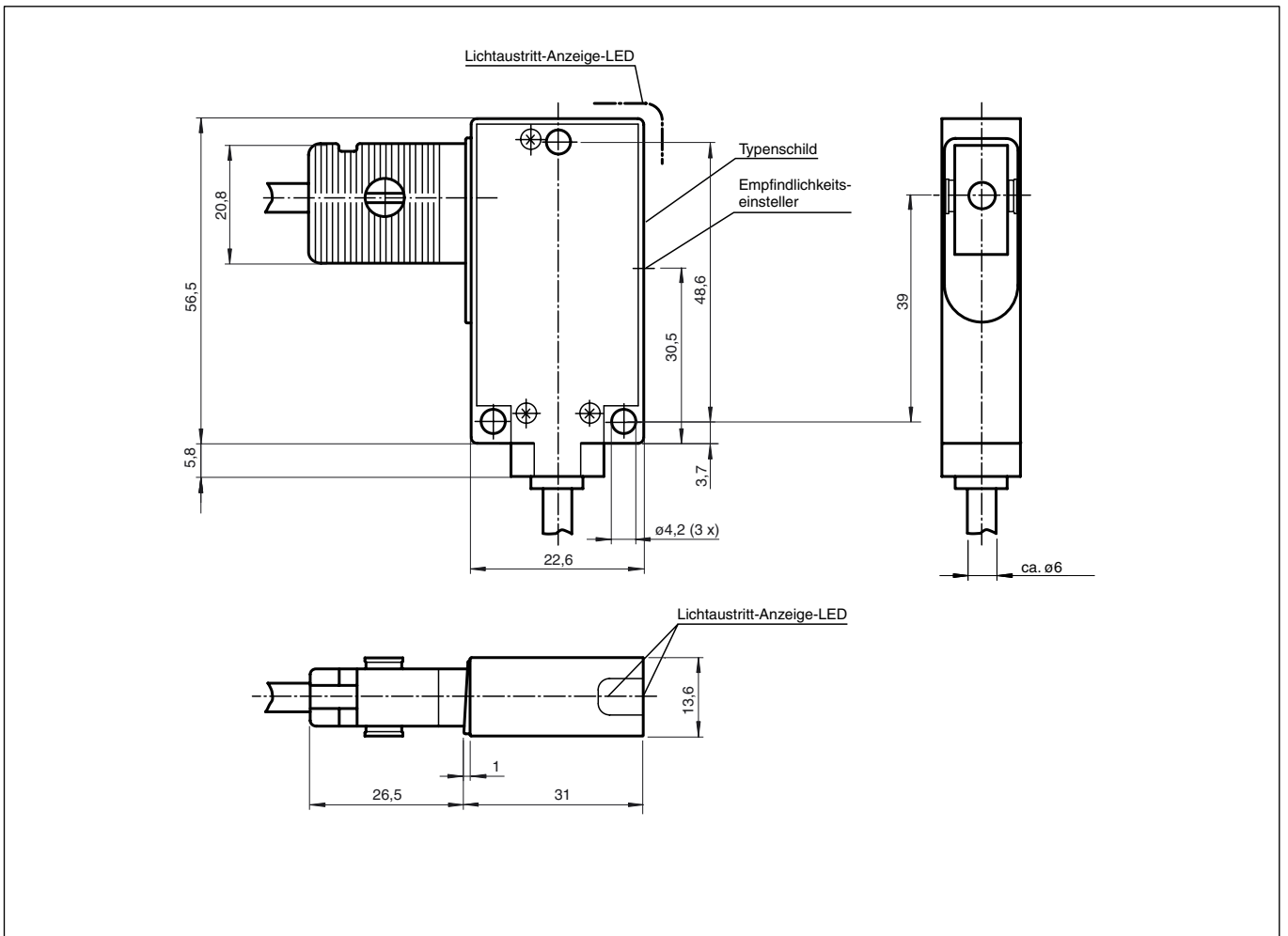

Elektrischer Anschluß

Veröffentlichungsdatum: 2005-09-12 15:00 Ausgabedatum: 2005-09-12 419652\_GER.xml

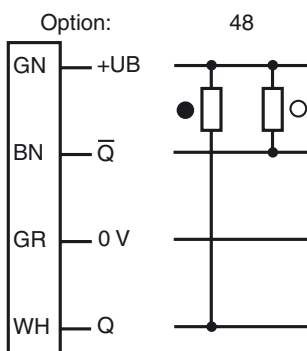

○ = Hellschaltung, ● = Dunkelschaltung

**Auswahltabelle Lichtleiter**

	Bezeichnung	Tastweite in mm mit			Abbildung
		MLV40-LL-IR	MLV40-LL-RT	SU14-LL	
Glasfaserlichtleiter - Einweg mit PVC-Ummantelung	LCE04-1,1-0,5-WC3	100	50	100	1
	LCE04-1,1-1,5-WC3	110	60	80	1
	LCE04-1,6-0,5-WC3	280	80	160	2
	LCE04-1,6-1,0-WC3	200	60	120	2
	LCE04-1,6-1,0-Z1	280	80	160	3
	LCE04-1,6-1,0-G	280	80	160	4
Glasfaserlichtleiter - Reflex mit PVC-Ummantelung	LCR04-1,1-0,5-WC3	50	25	40	5
	LCR04-1,6-1,0-WC3	100	50	80	6
	LCR04-1,6-0,5-WC2	50	20	40	7
	LCR04-1,6-0,5-Z1	80	40	80	8
	LCR04-1,6-1,0-Z1	100	50	80	8
	LCR04-1,6-1,0-G	100	50	80	9
Glasfaserlichtleiter - Einweg mit Metall-Silikon-Ummantelung	LLE04-1,6-1,0-G	280	40	160	10
	LLE04-1,6-1,0-Z1	280	40	160	11
	LLE04-1,6-1,0-WC3	280	35	160	12
	LLE04-1,6-1,0-WC15	250	35	140	13
Glasfaserlichtleiter- Reflex mit Metall-Silikon-Ummantelung	LLR04-1,6-0,5-G	90	40	80	14
	LLR04-1,6-1,0-G	100	50	80	14
	LLR04-1,6-0,5-QW1x4	80	35	60	18
	LLR04-1,6-1,0-QW1x4	60	40	40	18
	LLR04-1,6-0,5-WC3	80	35	60	15
	LLR04-1,6-1,0-WC3	100	50	80	15
	LLR04-1,9-1,0-WC5	100	50	70	16
	LLR04-1,6-1,0-Z1	110	50	80	17
Glasfaserlichtleiter - Einweg mit Metall-Ummantelung	LME04-0,8-0,5-Z1	80	40	60	19
	LME04-0,8-1,0-Z1	60	30	40	19
	LME04-1,6-0,5-Z1	160	80	120	20
	LME04-1,9-0,5-Z1	200	100	150	20
	LME04-1,6-1,0-WC3	120	60	80	23
	LME04-0,8-0,5-WC4	70	35	45	21
	LME04-1,6-1,5-WC4	120	60	80	22
Glasfaserlichtleiter - Reflex mit Metall-Ummantelung	LMR04-0,5-0,5-WC4	6	5	5	24
	LMR04-0,5-0,5-Z0	7	6	5	26
	LMR04-0,5-0,5-Z1	7	6	5	25
	LMR04-1,6-0,5-Z1	80	35	60	27
	LMR04-1,9-0,5-Z1	90	40	70	28
	LMR04-0,6-0,5-QW0,25/2	5	3	4	29

Andere Längen und Endstücke auf Anfrage



# MLV40-LL-RT/48/115

Adapter

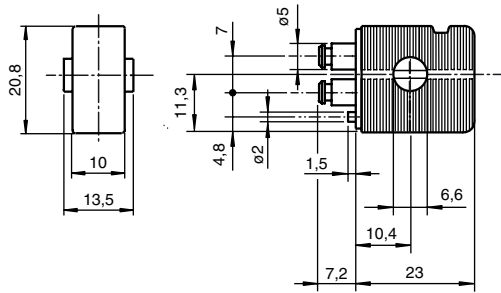

Einweg

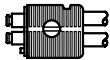

Reflex



Abb. 1



Abb. 2



Abb. 3

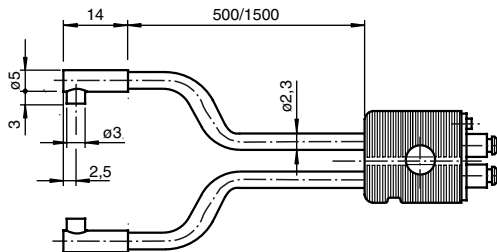

Abb. 4

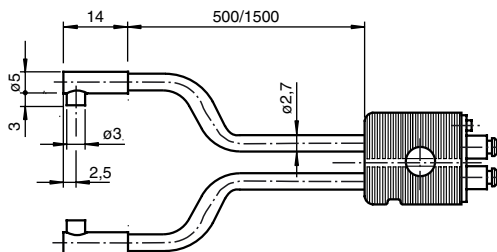

Abb. 5

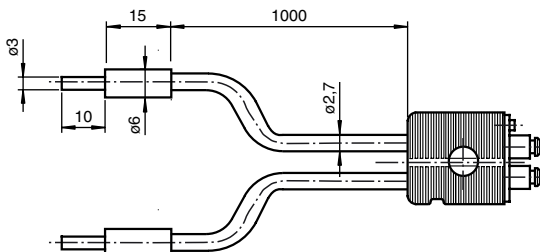

Abb. 6

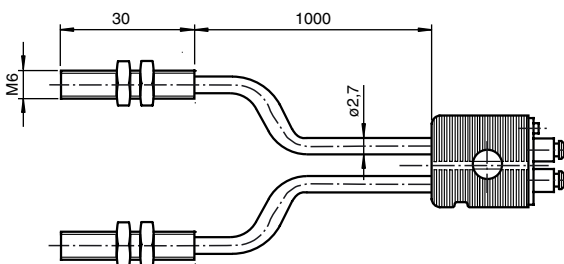

Abb. 7

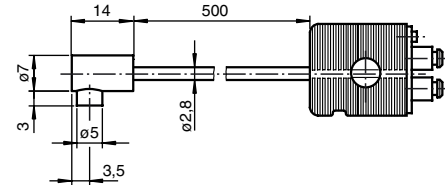

Abb. 8

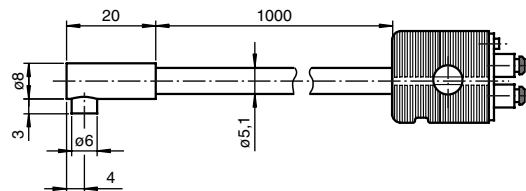

Abb. 9

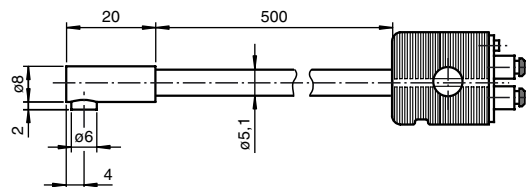

Veröffentlichungsdatum: 2005-09-12 15:00 Ausgabedatum: 2005-09-12 419652\_GER.xml



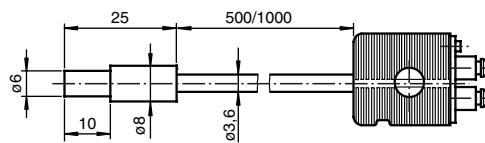
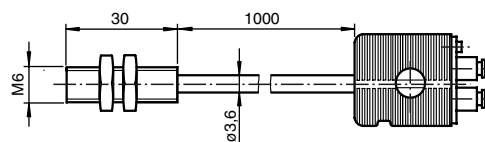

# MLV40-LL-RT/48/115

Abb. 10



Abb. 15



Abb. 11

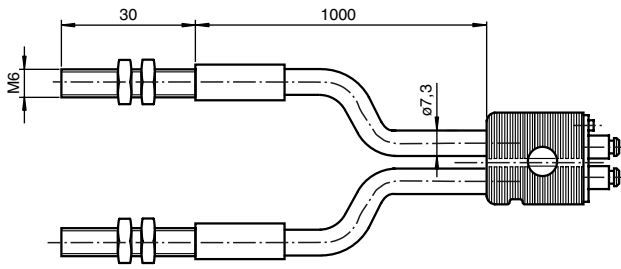

Abb. 16

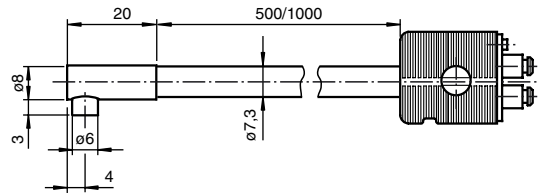

Abb. 12

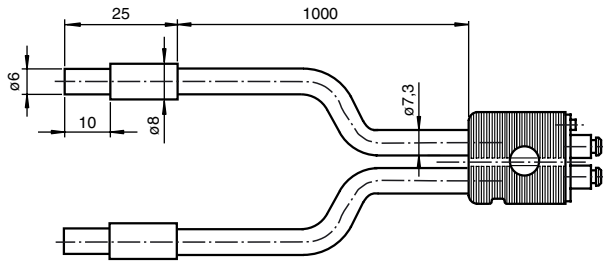

Abb. 17

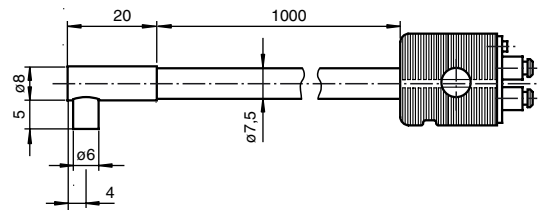

Abb. 13

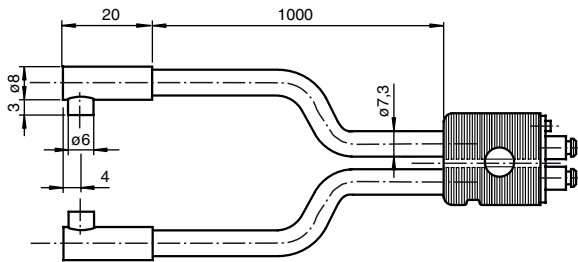

Abb. 18

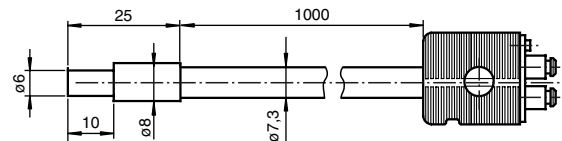

Abb. 14

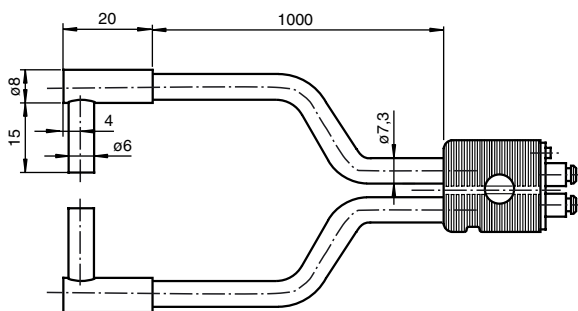

Abb. 19



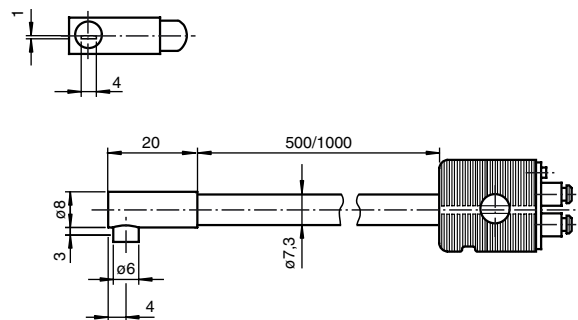

# MLV40-LL-RT/48/115

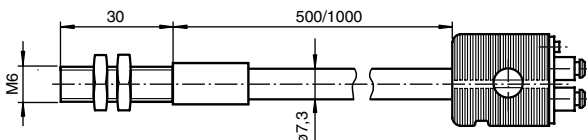
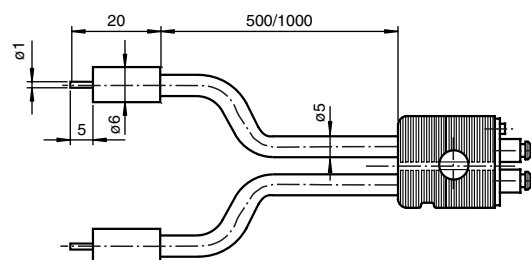
Abb. 20



Abb. 25



Abb. 21

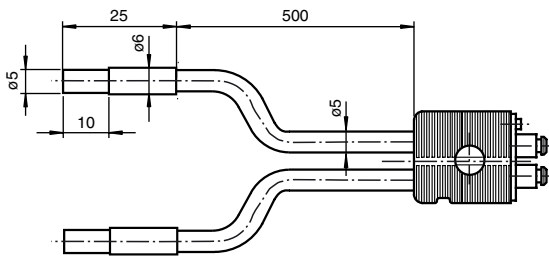

Abb. 26

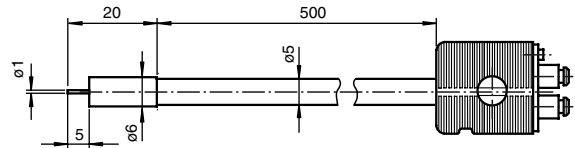

Abb. 22

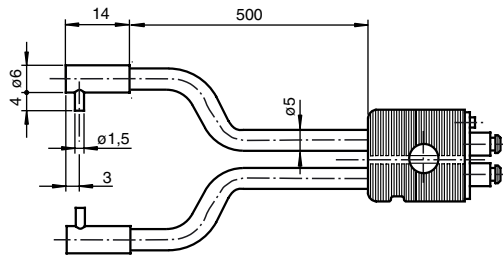

Abb. 27

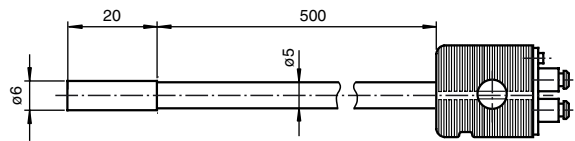

Abb. 23

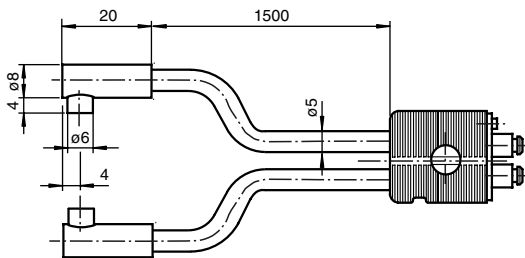

Abb. 28

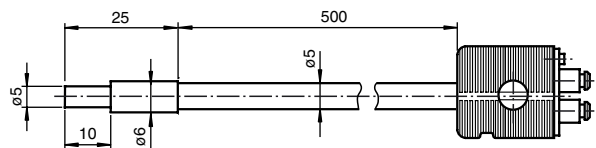

Abb. 24

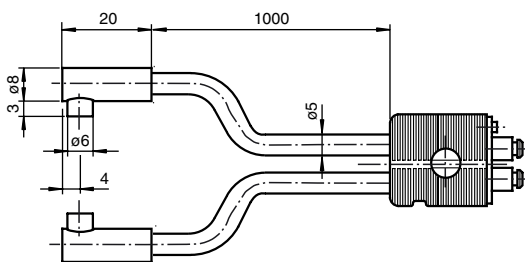

Abb. 29

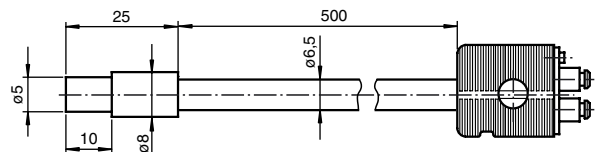

Veröffentlichungsdatum: 2005-09-12 15:00 Ausgabedatum: 2005-09-12 419652\_GER.xml

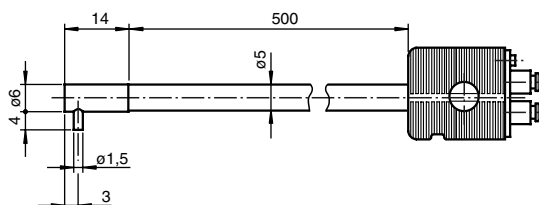
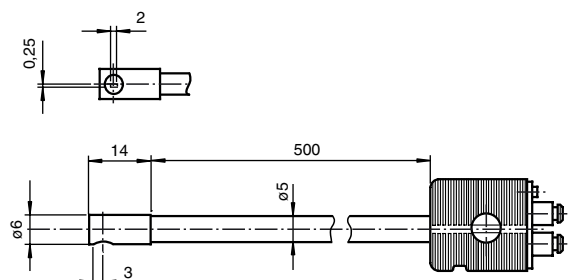