

LS600-DA-P-1,5/35/F1

Data transmission light beam switch

LS600-DA-P-1,5/35/F1

CE



- ◆ Detection range up to 190 m
- ◆ Data transmission up to 1.5 MBit/s
- ◆ Devices for PROFIBUS
- ◆ Easy adjustment by integrated alignment LED and finder scope
- ◆ Connection with spring-loaded terminals
- ◆ Sturdy aluminium housing
- ◆ Problem-free light beam interruption possible
- ◆ Mounting bracket included in delivery

Date of edition 01/18/05

General specifications

Effective detection range	0,5 ... 150 m
Threshold detection range	190 m
Light source	IRED
Approvals	CE
Alignment aid	Telescopic sight, frontal red LED flashing, off with Signal > sufficient stability control
Transmission mode	FSK
Light type	infrared, alternating light
Diameter of the light spot	3700 mm at a distance of 150 m
Angle of divergence	1,4 °
Ambient light limit	1000 Lux

Indicators/operating means

Data flow display	LED green: emitter LED yellow: receiver
Function display	LED red: 1-fold stability control LED green: Sufficient stability control
Operating elements	8-fold DIP-switch

Electrical specifications

Operating voltage	24 V DC ± 25 %
Data sampling blanking	emitter deactivation at 0 V
Data rate	9,6 ... 1500 kBit/s , adjustable
Operation frequency	F1 = 8,25 MHz
No-load supply current I ₀	450 mA

Interface

Interface type	PROFIBUS, electrically isolated
----------------	---------------------------------

Output

Output of the pre-fault indication	2 pnp-outputs, short-circuit proof, 30 V DC 0.1 A activated for single or sufficient stability control
------------------------------------	--

Standard conformity

Standards	EN 60947-5-2
-----------	--------------

Ambient conditions

Ambient temperature	-20 ... 50 °C (253 ... 323 K)
Storage temperature	-20 ... 75 °C (253 ... 348 K)

Mechanical specifications

Protection degree	IP65
Connection	4 PG9 screwed connections , spring-loaded terminals in the terminal compartment
Material	
Housing	aluminium
Optical face	glass
Mass	2000 g

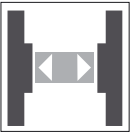

Electrical connection

Option:

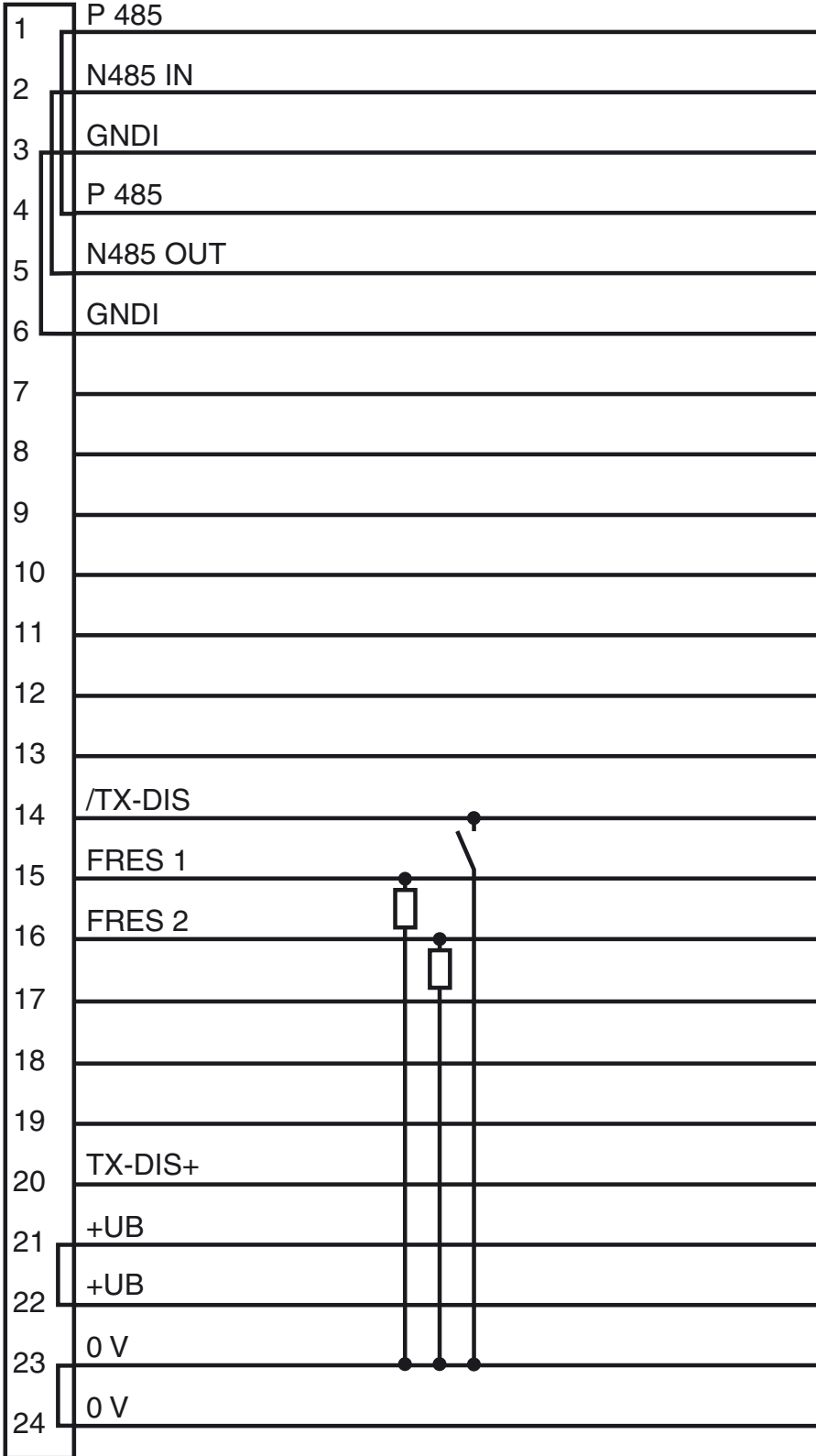

Dimensions

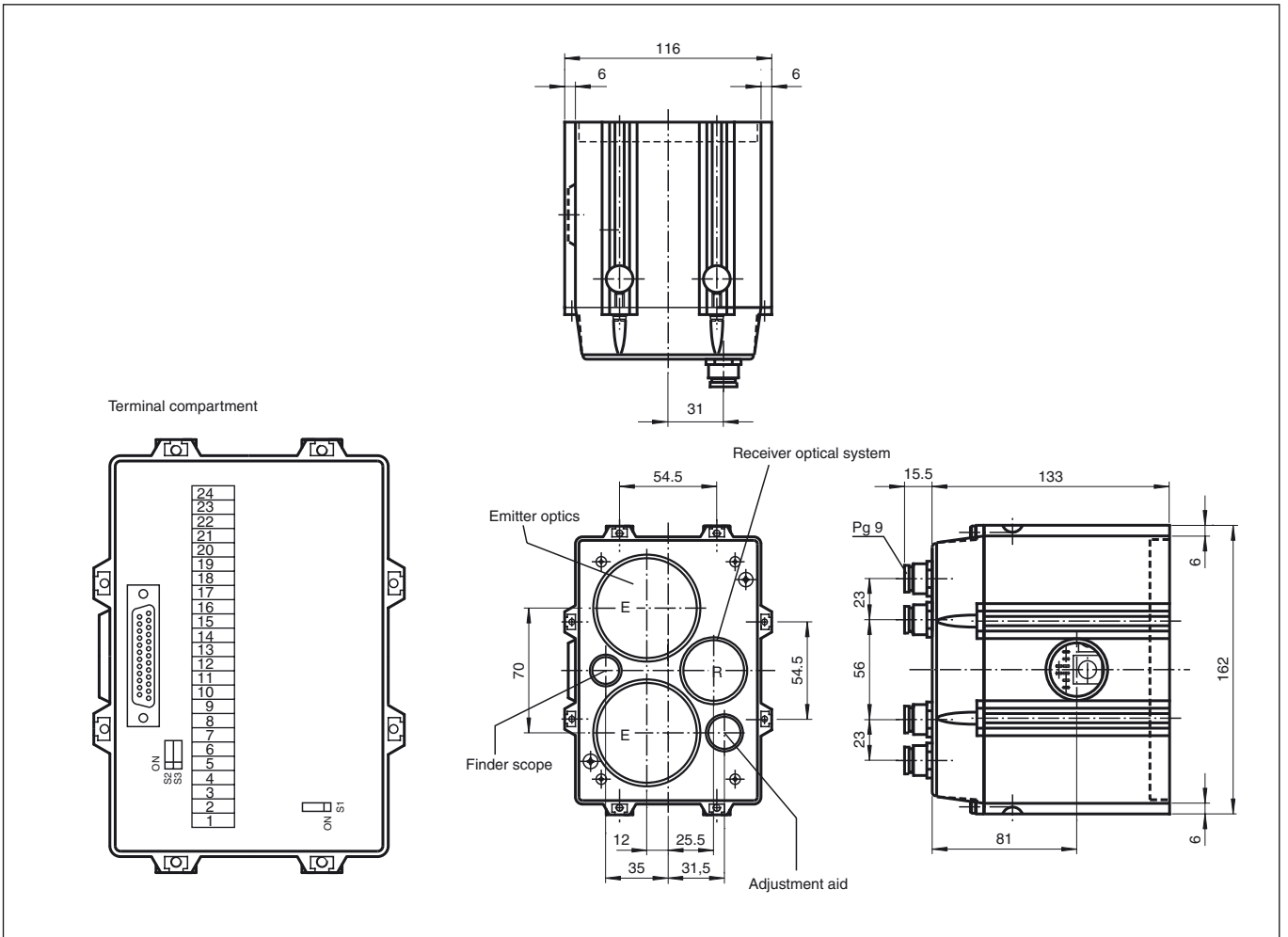

Diagrams

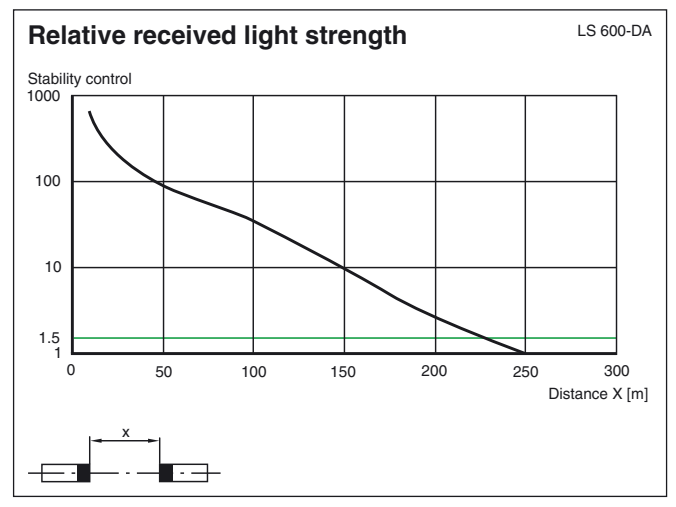
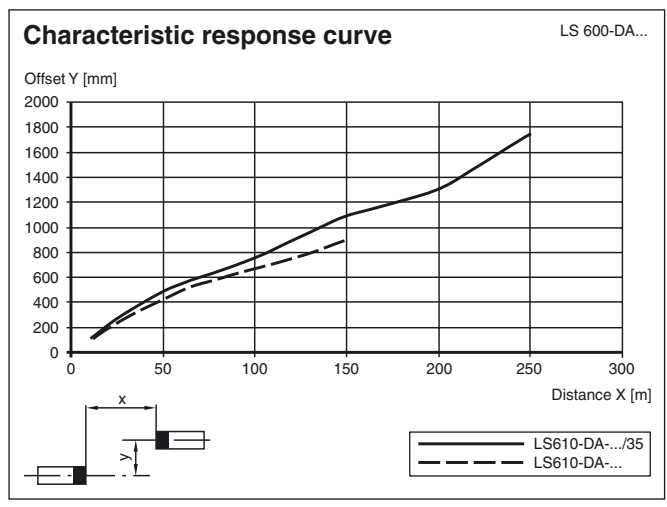

Date of edition 01/18/05

LS600-DA-P-1,5/35/F1

The LS600-DA-P-1,5 is a device for serial data transfer for PROFIBUS Systems with transfer rates up to 1.5 Mbit/s and detection range up to 190 m. The device can easily be employed for data rates and effective operating distances below these values. An LS 600-DA-P-1,5 with an average frequency F1 and an LS 600-DA-P-1,5 with an average frequency F2 are required for a data transfer route.

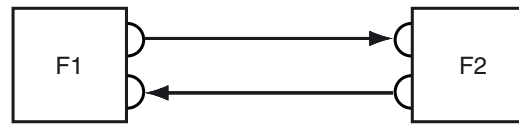

Data transfer

The data is transferred in both directions with modulated infrared light. The information that is present on the input interface is modulated to the carrier signal by means of the frequency shift keying (FSK). The corresponding demodulation and output to the output interface take place in the receiver. The complete transfer process takes place without the use of a protocol.

Function display/stability control

The red function display LED lights up if the level of the received signal is sufficient for an error-free transfer. The transfer is enabled beginning at this signal level. The green LED lights up for a sufficient stability control.

This system flashes red after the device is turned on and thus makes the receiver clearly visible at a great distance. If the reception level for the transfer exceeds the minimum required value, the flashing alignment aid is turned off. If the reception level for the transfer exceeds the minimum required value, the flashing alignment aid is turned off.

If data is received, a yellow LED lights up, if data is transmitted, a green LED lights up.

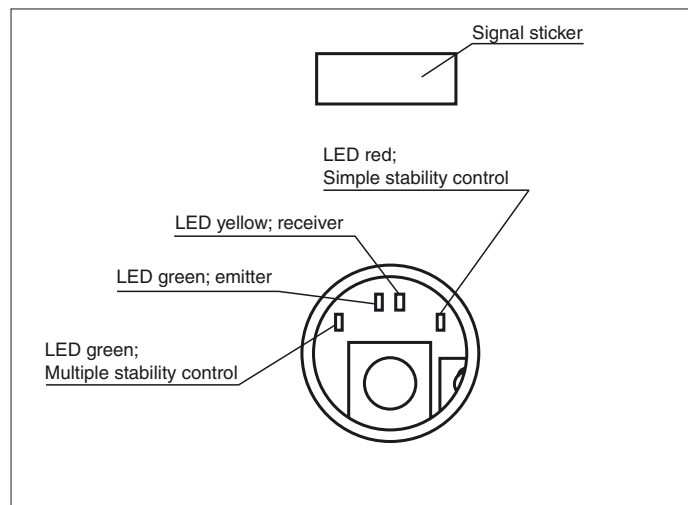

Switch position in the terminal compartment

The housing connection of the data shield can be switched from galvanic (ON) to capacitive (OFF) with the S1 switch on the terminal print (10 nF/630 V).

S1 ON = cable shield directly on the housing
 OFF = cable shield capacitive on the housing

S2 and S3 ON = PROFIBUS inputs and outputs, connected (for commissioning of tested electronics unit)
 OFF = PROFIBUS inputs and outputs, not connected (standard-PROFIBUS)

Interface

The LS 600 DA-P has an interface adapter. To be able to ensure that the PROFIBUS telegrams are monitored on the light reception side and telegrams that are not correct for the PROFIBUS are suppressed, the repeater function must be activated.

The signals are then regenerated in the correct bit and character format. Telegrams are transmitted on the bus with quartz stabilisation.

If the repeater function is activated, the baud rate must be correctly adjusted with the Sd switch. If the setting is incorrect, there is no transfer.

A bus short-circuit involving a segment, for example, is not transferred to the other side. During a light beam interruption the data transfer is blocked in both directions.

If the repeater function is deactivated, you can select the behaviour on the bus side when the light beam is interrupted with the Sa switch.

ON = "BREAK" (duration low)
OFF = data output Tri-state

Each PROFIBUS line must have a termination. With an optical data coupler at the end of a bus line, the PROFIBUS has to be provided with a termination combination.

The bus termination can be turned on and off with the Sb and Sc switch on the interface print.

Switches Sb, Sc: PROFIBUS termination:

On: active
 Off: without terminal resistor

The Sb and Sc switches must only be used together!

Switch Sd: Baudrate setting

Sd.1: 1.5 MB
 Sd.2: 500 k
 Sd.3: 375 k
 Sd.4: 187.5 k
 Sd.5: 93.75 k
 Sd.6: 19.2 k
 Sd.7: 9.6 k

Sd.8 = "off": repeater active
 Sd.8 = "on": repeater inactive

Switch Sa: Behavior when light beam is interrupted

On: special behaviour
 Off: high-ohm

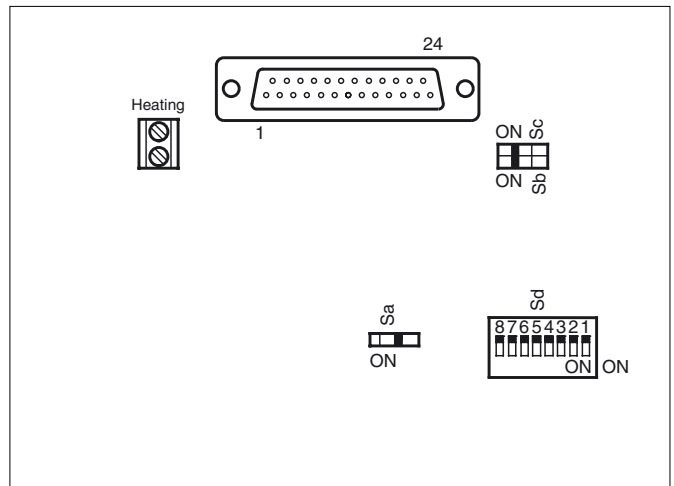

Mounting bracket

