



Product Number

NBN25-L2K-E0-V1-Y236073

Features

- 3-wire DC
- Quick mounting bracket
- 4-way LED indicator

Connection

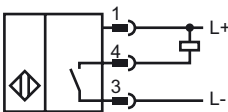

Pinout

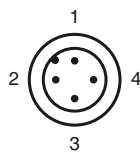

Wire colors in accordance with EN 60947-5-2

1	BN	(brown)
2	WH	(white)
3	BU	(blue)
4	BK	(black)

Technical Data

General specifications

Switching element function	NPN	NO
Rated operating distance	s_n	25 mm (Steel ST37 / 1.0037)
Installation		not embeddable
Output polarity		DC
Assured operating distance	s_a	0 ... 16 mm

Nominal ratings

Installation conditions		
X		≥ 40 mm
Oscillator frequency	f_O	102 kHz
Operating voltage	U_B	10 ... 30 V DC
Switching frequency	f	0 ... 100 Hz
Hysteresis	H	typ. 5 %
Reverse polarity protected		reverse polarity protected
Short-circuit protection		pulsing
Voltage drop	U_d	≤ 2 V
Operating current	I_L	0 ... 200 mA
Off-state current	I_r	0 ... 0.5 mA
No-load supply current	I_o	≤ 20 mA
Operating voltage display		LED, green
Indication of the switching state		LED, yellow

Functional safety related parameters

MTTF _d	1510 a
Mission Time (T _M)	20 a
Diagnostic Coverage (DC)	0 %

Ambient conditions

Ambient temperature	0 ... 50 °C (32 ... 122 °F)
Storage temperature	-40 ... 85 °C (-40 ... 185 °F)

Mechanical specifications

Connection type	Device connector M12 x 1 , 4-pin
Housing material	PA-GF35
Sensing face	PA-GF35
Protection degree	IP69K

General information

Supplementary information	Sensing range 17 mm tested on aluminum foil
---------------------------	---

Compliance with standards and directives

Standard conformity	
Standards	EN 60947-5-2:2007 IEC 60947-5-2:2007

Approvals and certificates

Protection class	II
Rated insulation voltage	U_i 253 V
Design-impulse-voltage withstand	U_{imp} 4000 V
UL approval	cULus Listed, General Purpose
CSA approval	cCSAus Listed, General Purpose
CCC approval	Products with a maximum operating voltage of ≤ 36 V do not bear a CCC marking because they do not require approval.

Installation Conditions

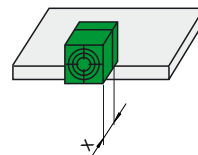

Dimensions

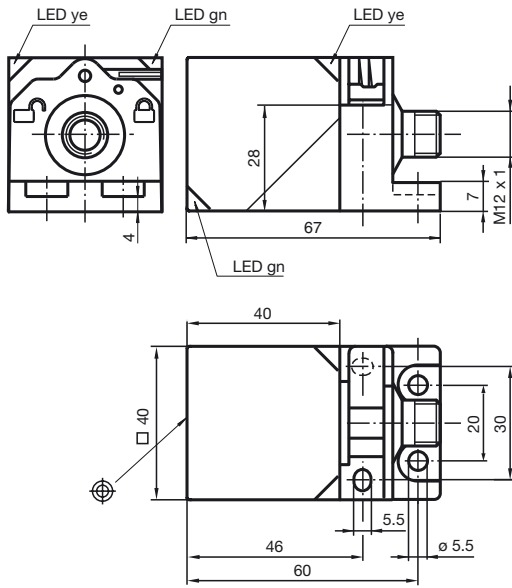

Accessories

- V1-G**
Field attachable female cordset
- V1-G-2M-PUR**
Cable socket, M12, 4-pin, PUR cable
- MHW 01**
Modular mounting bracket
- MH 02-L**
Mounting aid
- V1-W-2M-PUR**
Cable socket, M12, 4-pin, PUR cable
- V1-W**
Field attachable female cordset