



Model Number

VMBI-2+PE/L1R-Y226534

Valve connector Form B (Ind), non pre-wired

Features

- Pre-assembled
- Individually packaged
- With wiring diagram imprint

Dimensions

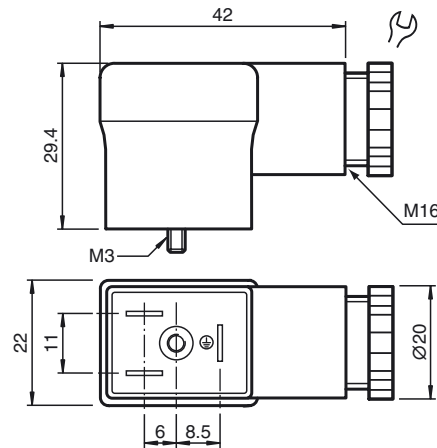

Technical data

General specifications

Number of pins	2 + PE
Connection 1	Valve connector industrial version
Construction type 1	right angle

Indicators/operating means

LED red	Operating display
---------	-------------------

Electrical specifications

Operating voltage	U_B	10 ... 50 V AC/DC
Operating current		max. 10 A
Volume resistance		< 10 m Ω

Ambient conditions

Ambient temperature	-40 ... 70 °C (-40 ... 158 °F)
---------------------	--------------------------------

Mechanical specifications

Protection degree	IP65
Connection	Valve connector Form B screw terminals for max. 1.5 mm ² M16 cable gland

Material	
Contacts	CuZn ; CuSn
Body	PA
Cable	
Sheath diameter	6 ... 8 mm

General information

Scope of delivery	Contains seal and screw
-------------------	-------------------------

Electrical connection

