



Model Number

NBN30-U2-E2

Features

- 30 mm not embeddable
- 4 LEDs indicator for 360° visibility

Connection

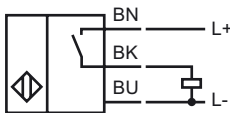

Accessories

MHW 01

Modular mounting bracket

Dimensions

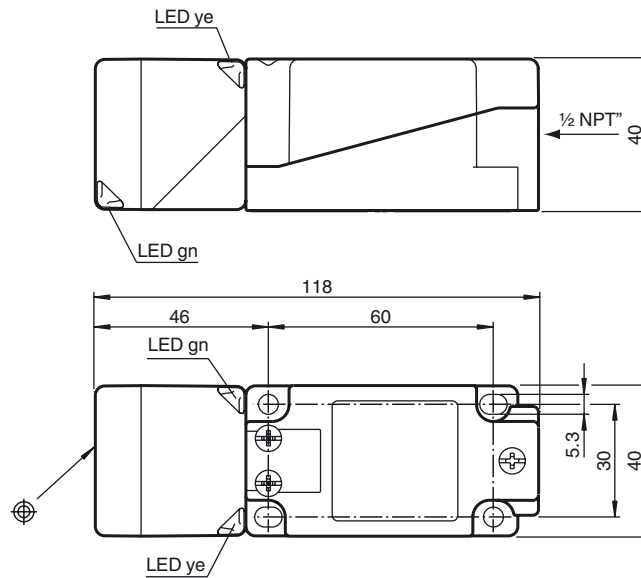

Technical Data

General specifications

Switching element function	PNP	NO
Rated operating distance	s_n	30 mm
Installation	not embeddable	
Output polarity	DC	
Assured operating distance	s_a	0 ... 24.3 mm
Reduction factor r_{AI}	0.33	
Reduction factor r_{Cu}	0.31	
Reduction factor r_{303}	0.74	
Reduction factor r_{Brass}	0.38	

Nominal ratings

Operating voltage	U_B	10 ... 30 V
Switching frequency	f	0 ... 150 Hz
Hysteresis	H	typ. 5 %
Reverse polarity protected	reverse polarity protected	
Short-circuit protection	pulsing	
Voltage drop	U_d	≤ 2 V
Operating current	I_L	0 ... 200 mA
Off-state current	I_r	0 ... 0.5 mA typ. 0.01 mA
No-load supply current	I_0	≤ 20 mA
Operating voltage display	LED, green	
Indication of the switching state	LED, yellow	

Functional safety related parameters

MTTF _d	1510 a
Mission Time (T _M)	20 a
Diagnostic Coverage (DC)	0 %

Ambient conditions

Ambient temperature	-25 ... 85 °C (-13 ... 185 °F)
---------------------	--------------------------------

Mechanical specifications

Connection type	screw terminals
Core cross-section	≤ 2.5 mm ²
Housing material	PA/metal with epoxy powder coating
Sensing face	PA
Housing base	plastic
Protection degree	IP68 / IP69K
Mass	225 g
Note	Tightening torque: 1.8 Nm (housing) Tightening torque: 1.0 Nm (Screw terminal)

Compliance with standards and directives

Standard conformity	
Standards	EN 60947-5-2:2007 IEC 60947-5-2:2007

Approvals and certificates

UL approval	cULus Listed, General Purpose
CSA approval	cCSAus Listed, General Purpose
CCC approval	Products with a maximum operating voltage of ≤ 36 V do not bear a CCC marking because they do not require approval.

Release date: 2011-08-15 14:33 Date of issue: 2011-08-15 203078_eng.xml