

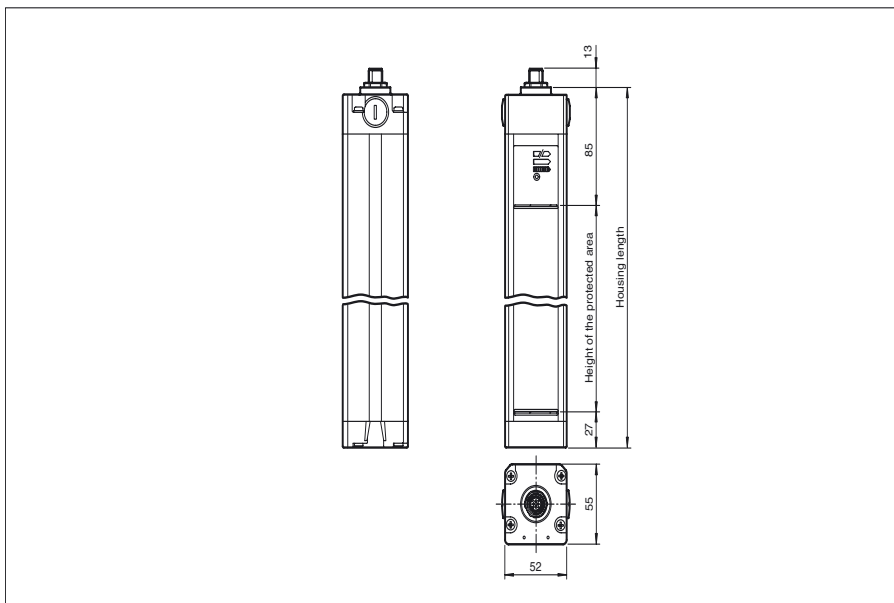

**Dimensions**



**Model Number**

**SLC-4/151**  
with 2 separate fail-safe semiconductor outputs

**Features**

- Sensing range up to 20 m
- 2, 3, and 4-beam design
- Beam distance 300, 400 and 500 mm
- Self-monitoring (type 4 according to IEC/EN 61496-1)
- Start/Restart disable
- Protection degree IP67
- 7-segment diagnostic display
- Pre-fault indication
- Connection via appliance socket M12 x b1
- Safety outputs OSSD in potential-separated semiconductor version
- Optional with relay monitor (Option 129)

**Electrical connection**

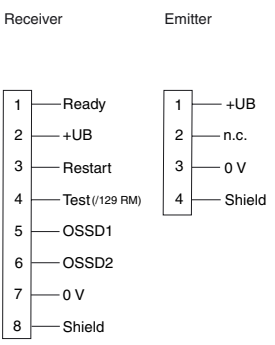

**Pinout**

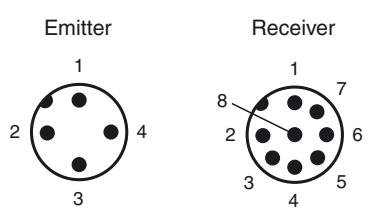

Release date: 2012-07-11 10:00 Date of issue: 2012-07-11 199767\_eng.xml

**Technical data****General specifications**

Effective detection range	0.2 ... 20 m
Light source	IREDD
Light type	modulated infrared light
Approvals	TÜV, cULus
Tests	IEC/EN 61496
Safety type according to IEC/EN 61496	4
Marking	CE
Target size	50 mm
Beam spacing	300 mm
Number of beams	4
Operating mode	can be selected with or without start/restart disable
Angle of divergence	< 5 °

**Functional safety related parameters**

Safety Integrity Level (SIL)	SIL 3
Performance level (PL)	PL e
Category	Cat. 4
Mission Time (T <sub>M</sub> )	20 a
PFH <sub>d</sub>	5.8 E-9
Type	4

**Indicators/operating means**

Operating display	7-segment display in emitter
Diagnostics display	7-segment display in receiver
Function display	in receiver: LED red: OSSD off LED green: OSSD on LED yellow: Protected area free, system start-ready
Pre-fault indication	LED orange
Controls	switch for start/restart disable, transmission coding

**Electrical specifications**

Operating voltage	U <sub>B</sub>	24 V DC (-30 %/+25 %)
No-load supply current	I <sub>0</sub>	Emitter: 100 mA , receiver 150 mA
Protection class		III

**Input**

Activation current	approx. 10 mA
Activation time	0.03 ... 1 s
Test input	Reset-input for system test (not for option /129)
Function input	Start release

**Output**

Safety output	2 separated fail safe semiconductor outputs
Signal output	1 PNP, max. 100 mA for start readiness
Switching voltage	Operating voltage -2 V
Switching current	max. 0.5 A
Response time	10 ms

**Ambient conditions**

Ambient temperature	0 ... 55 °C (32 ... 131 °F)
Storage temperature	-25 ... 70 °C (-13 ... 158 °F)
Relative humidity	max. 95 %, not condensing

**Mechanical specifications**

Protection degree	IP67
Connection	Emitter: M12 connector, 4-pin Receiver: M12 connector, 8-pin
Material	
Housing	extruded aluminum profile, RAL 1021 (yellow) coated
Optical face	Plastic pane
Mass	Per 3450 g

**General information**

System components	
Emitter	SLC-4-T / 92
Receiver	SLC-4-R / 151

**Compliance with standards and directives**

Directive conformity	
Machinery Directive 2006/42/EC	EN ISO 13849-1:2008 EN 61496-1:2004/A1:2008
EMC Directive 2004/108/EC	EN 61000-6-4:2007 + A1:2011
Standard conformity	
Standards	IEC 61496-2:2006 EN 50178:1997

**Approvals and certificates**

CE conformity	CE
UL approval	cULus Listed
CCC approval	Products with a maximum operating voltage of ≤36 V do not bear a CCC marking because they do not require approval.
TÜV approval	TÜV

Curves/Diagrams

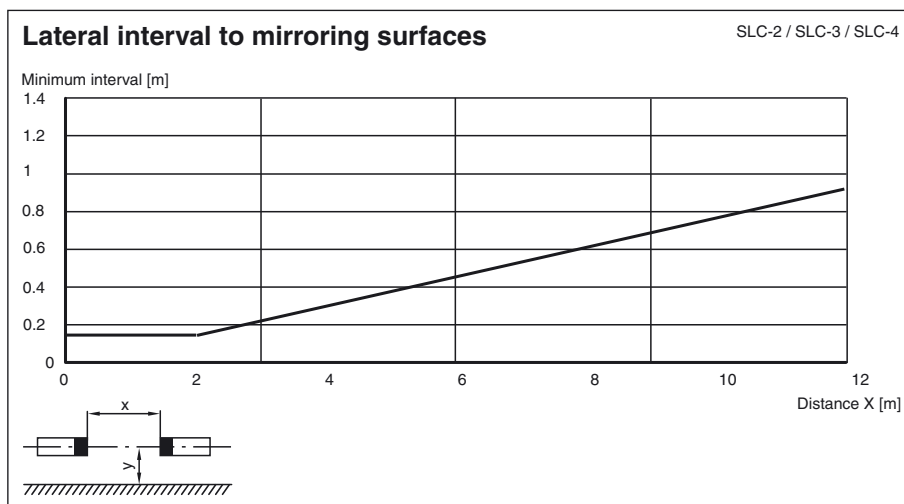
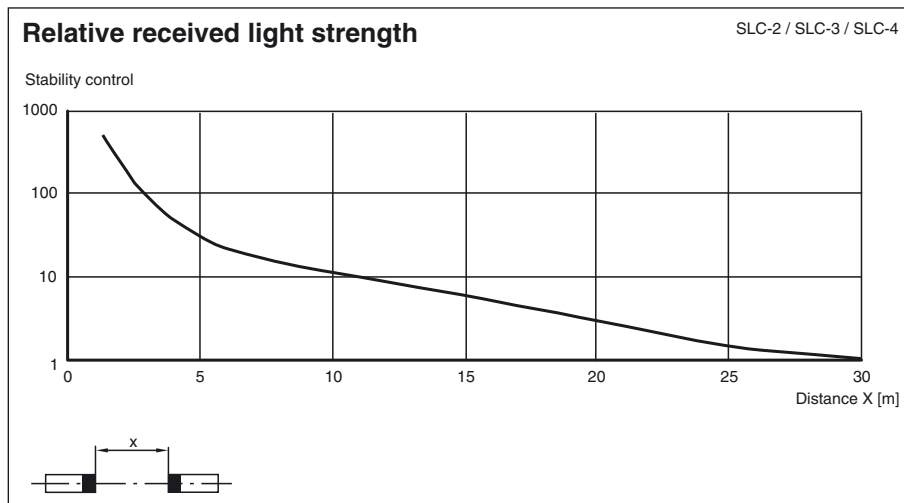
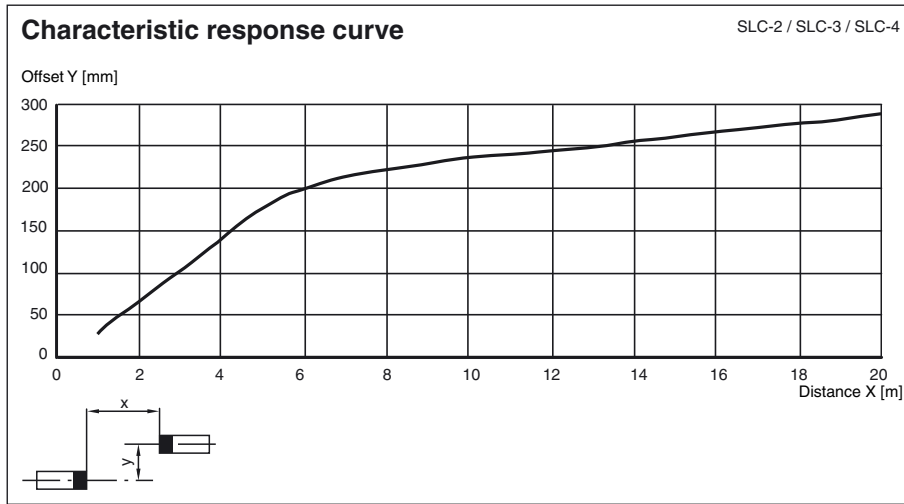

Release date: 2012-07-11 10:00 Date of issue: 2012-07-11 199767\_eng.xml

## Additional information

### Profile dimensions, front view

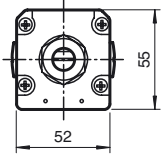

## System accessories

- Mounting set SLC
- Protective glass pieces for SLC (to protect the optically functional surface)
- Lateral screwed connection SLC
- Mirror 2, 3 or 4-beam for SLC (for multi-side securing of hazardous areas)
- Laser alignment aid BA SLC
- Profile alignment aid PA SLP/SLC
- Ground pillar UC SLP/SLC
- Housing for ground pillar Enclosure UC SLP/SLC
- Collision protector Damping UC SLP/SLC