

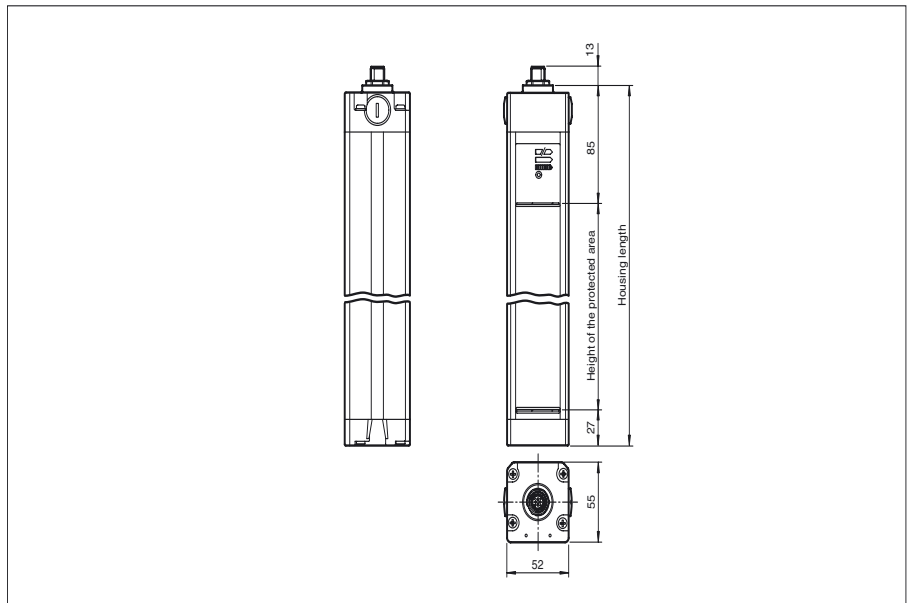

Dimensions



Model Number

SLC30-300/151

with 2 separate fail-safe semiconductor outputs

Features

- Sensing range up to 15 m
- Resolution 30 mm (hand protection)
- Self-monitoring (type 4 according to IEC/EN 61496-1)
- Master/Slave detection, Plug and Play
- Start/Restart disable
- Protection degree IP67
- Integrated function display
- Pre-fault indication
- Optional with relay monitor (Option 129)
- Connection via appliance socket M12 x b1
- Safety outputs OSSD in potential-separated semiconductor version
- Protective field height up to 1800 mm

Electrical connection

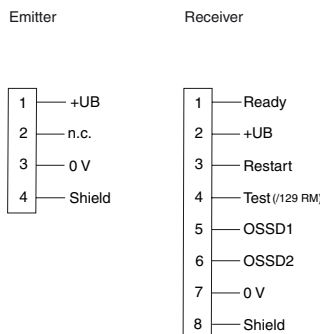

Pinout

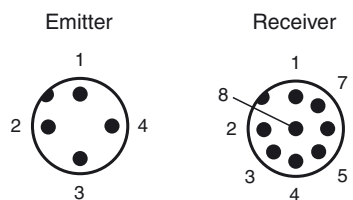

Accessories

PG SLC-300

Protective glass panes for SLC series

BA SLC

laser alignment aid for safety light curtains series SLC

Release date: 2012-08-01 11:57 Date of issue: 2012-08-01 199741_eng.xml

Technical data**General specifications**

| | |
|---------------------------------------|---|
| Effective detection range | 0.2 ... 15 m |
| Light source | IREDD |
| Light type | modulated infrared light |
| Approvals | TÜV, cULus |
| Tests | IEC/EN 61496 |
| Safety type according to IEC/EN 61496 | 4 |
| Marking | CE |
| Width of protected area | 0.2 ... 15 m |
| Protection field height | 300 mm |
| Number of beams | 16 |
| Operating mode | can be selected with or without start/restart disable |
| Optical resolution | 30 mm |
| Angle of divergence | < 5 ° |

Functional safety related parameters

| | |
|--------------------------------|----------|
| Safety Integrity Level (SIL) | SIL 3 |
| Performance level (PL) | PL e |
| Category | Cat. 4 |
| Mission Time (T _M) | 20 a |
| PFH _d | 1.35 E-8 |
| Type | 4 |

Indicators/operating means

| | |
|----------------------|--|
| Operating display | 7-segment display in emitter |
| Diagnostics display | 7-segment display in receiver |
| Function display | in receiver: LED red: OSSD off LED green: OSSD on LED yellow: Protected area free, system start-ready |
| Pre-fault indication | LED orange |
| Controls | switch for start/restart disable, transmission coding |

Electrical specifications

| | | |
|------------------------|----------------|--------------------------------------|
| Operating voltage | U _B | 24 V DC (-30 %/+25 %) |
| No-load supply current | I ₀ | Emitter: ≤ 100 mA receiver: ≤ 150 mA |
| Protection class | | III |

Input

| | |
|--------------------|---|
| Activation current | approx. 10 mA |
| Activation time | 0.03 ... 1 s |
| Test input | Reset-input for system test (not for option /129) |
| Function input | Start release |

Output

| | |
|-------------------|---|
| Safety output | 2 separated fail safe semiconductor outputs |
| Signal output | 1 PNP, max. 100 mA for start readiness |
| Switching voltage | Operating voltage -2 V |
| Switching current | max. 0.5 A |
| Response time | 10 ms |

Ambient conditions

| | |
|---------------------|--------------------------------|
| Ambient temperature | 0 ... 55 °C (32 ... 131 °F) |
| Storage temperature | -25 ... 70 °C (-13 ... 158 °F) |
| Relative humidity | max. 95 %, not condensing |

Mechanical specifications

| | |
|-------------------|--|
| Housing length L | 410 mm |
| Protection degree | IP67 |
| Connection | Emitter: M12 connector, 4-pin Receiver: M12 connector, 8-pin |
| Material | |
| Housing | extruded aluminum profile, RAL 1021 (yellow) coated |
| Optical face | Plastic pane |
| Mass | Per 1200 g |

General information

| | |
|-------------------|-------------------|
| System components | |
| Emitter | SLC30-300-T / 92 |
| Receiver | SLC30-300-R / 151 |

Compliance with standards and directives

| | |
|--------------------------------|---|
| Directive conformity | |
| Machinery Directive 2006/42/EC | EN ISO 13849-1:2008 EN 61496-1:2004/A1:2008 |
| EMC Directive 2004/108/EC | EN 61000-6-4:2007 + A1:2011 |
| Standard conformity | |
| Standards | IEC 61496-2:2006 EN 50178:1997 |

Approvals and certificates

| | |
|---------------|--|
| CE conformity | CE |
| UL approval | cULus Listed |
| CCC approval | Products with a maximum operating voltage of ≤36 V do not bear a CCC marking because they do not require approval. |
| TÜV approval | TÜV |

Curves/Diagrams



Release date: 2012-08-01 11:57 Date of issue: 2012-08-01 199741_eng.xml

Notes

Master slave mode

Master: SLC...-... (semiconductor)
or
SLC...-.../31 (relay)
Slave: SLC...-...-S

Using slaves makes it possible to lengthen protective fields or to form protective fields that lie in more than just one level. When you select slaves that can be connected, you should take into consideration that the maximum number of 96 light rays must not be exceeded.

There are slaves for transmitters and receivers. These may simply be connected to the master light curtain. As many as 2 slaves may be connected respectively to the transmitter and receiver unit.

Installation:

- 1 The end cap should be screwed off for the light curtain (without cable gland).
- 2 The plug-in jumper on the connectors of the printed circuit board, which is now visible, should be removed.
- 3 The slave is designed so that the cap located on the cable connector can be plugged directly onto the open end of the light curtain with the printed circuit board.
- 4 After you have screwed on the connection cap, the system is complete.

System accessories

- Mounting set SLC
- Test rods SLC14/SLC30/SLC60
- Protective glass pieces for SLC (to protect the optically functional surface)
- Lateral screwed connection SLC
- Profile alignment aid
- Laser alignment aid SLC
- Mirror for SLC (for securing hazardous areas on multiple sides)
- Ground pillar UC SLP/SLC
- Housing for pillar
Enclosure UC SLP/SLC
- Collision protector
Damping UC SLP/SLC