

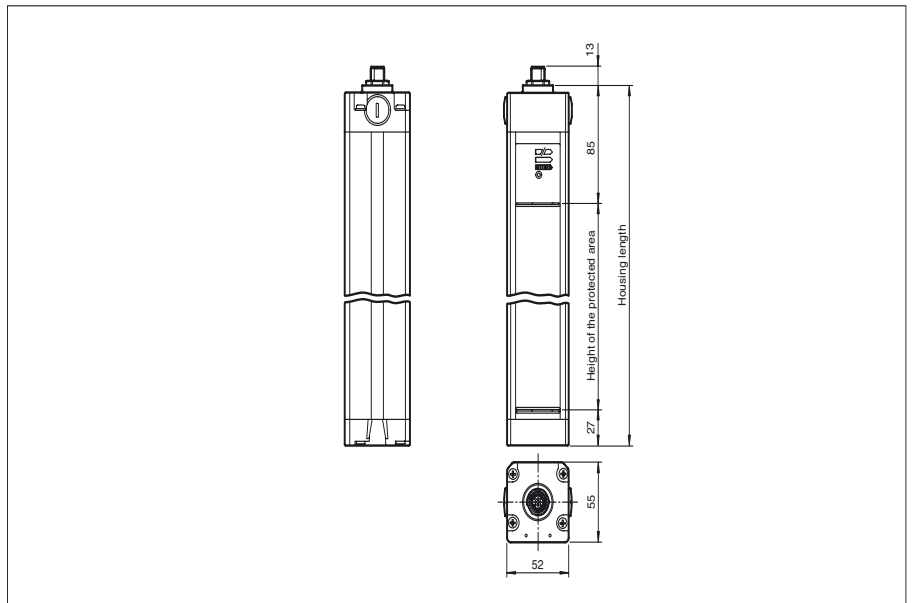

Dimensions



Model Number

SLC14-1350/129/130/151

with 2 separate fail-safe semiconductor outputs

Features

- Sensing range up to 5 m
- Resolution 14 mm (finger protection)
- Self-monitoring (type 4 according to IEC/EN 61496-1)
- Master/Slave detection, Plug and Play
- Very short response time
- Protection degree IP67
- Integrated function display
- Pre-fault indication
- Connection via appliance socket M12 x b1
- Safety outputs OSSD in potential-separated semiconductor version
- Protective field height up to 1800 mm
- Start/Restart disable preset by Option /129

Electrical connection

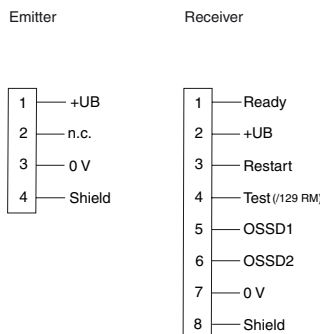

Pinout

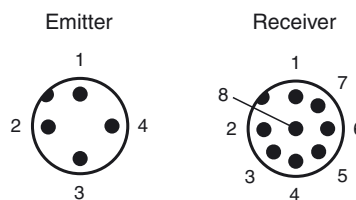

Accessories

PG SLC-1350
Protective glass panes for SLC series

BA SLC
laser alignment aid for safety light curtains series SLC

Release date: 2012-07-11 10:01 Date of issue: 2012-07-11 199736_eng.xml

Technical data**General specifications**

Effective detection range	0.2 ... 5 m
Light source	IREDD
Light type	modulated infrared light
Approvals	TÜV, cULus
Tests	IEC/EN 61496
Safety type according to IEC/EN 61496	4
Marking	CE
Width of protected area	0.2 ... 5 m
Protection field height	1350 mm
Number of beams	144
Operating mode	can be selected with or without start/restart disable
Optical resolution	14 mm
Angle of divergence	< 5 °

Functional safety related parameters

Safety Integrity Level (SIL)	SIL 3
Performance level (PL)	PL e
Category	Cat. 4
Mission Time (T _M)	20 a
PFH _d	2.28 E-8
Type	4

Indicators/operating means

Operating display	7-segment display in emitter
Diagnostics display	7-segment display in receiver
Function display	in receiver: LED red: OSSD off LED green: OSSD on LED yellow: Protected area free, system start-ready
Pre-fault indication	LED orange
Controls	switch for start/restart disable, transmission coding

Electrical specifications

Operating voltage	U _B	24 V DC (-30 %/+25 %)
No-load supply current	I ₀	Emitter: ≤ 100 mA receiver: ≤ 150 mA
Protection class		III

Input

Activation current	approx. 10 mA
Activation time	0.03 ... 1 s
Test input	Reset-input for system test (not for option /129)
Function input	Start release

Output

Safety output	2 separated fail safe semiconductor outputs
Signal output	1 PNP, max. 100 mA for start readiness
Switching voltage	Operating voltage -2 V
Switching current	max. 0.5 A
Response time	28 ms

Ambient conditions

Ambient temperature	0 ... 55 °C (32 ... 131 °F)
Storage temperature	-25 ... 70 °C (-13 ... 158 °F)
Relative humidity	max. 95 %, not condensing

Mechanical specifications

Housing length L	1460 mm
Protection degree	IP67
Connection	Emitter: M12 connector, 4-pin Receiver: M12 connector, 8-pin
Material	
Housing	extruded aluminum profile, RAL 1021 (yellow) coated
Optical face	Plastic pane
Mass	Per 4350 g

General information

System components	
Emitter	SLC 14 - 1350 -T/ 130 / 92
Receiver	SLC14 - 1350 -R/ 129 / 130 / 151

Compliance with standards and directives

Directive conformity	
Machinery Directive 2006/42/EC	EN ISO 13849-1:2008 EN 61496-1:2004/A1:2008
EMC Directive 2004/108/EC	EN 61000-6-4:2007 + A1:2011
Standard conformity	
Standards	IEC 61496-2:2006 EN 50178:1997

Approvals and certificates

CE conformity	CE
UL approval	cULus Listed
CCC approval	Products with a maximum operating voltage of ≤36 V do not bear a CCC marking because they do not require approval.
TÜV approval	TÜV

Curves/Diagrams

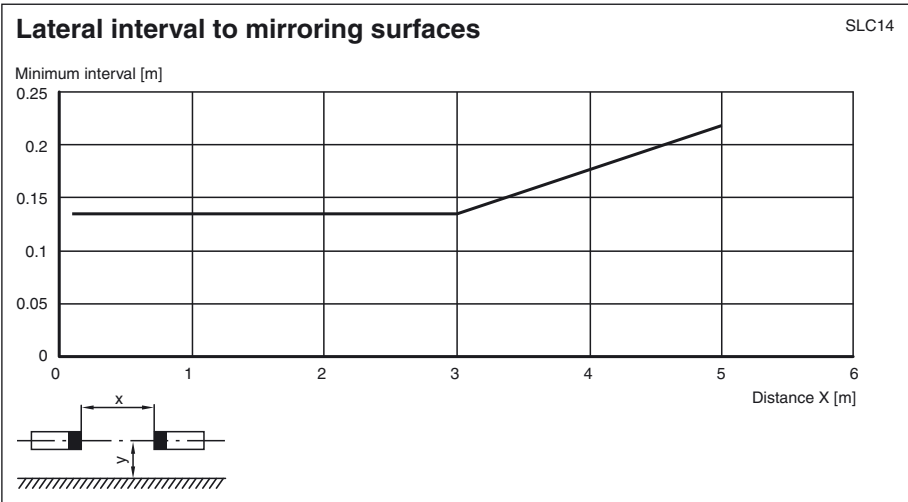
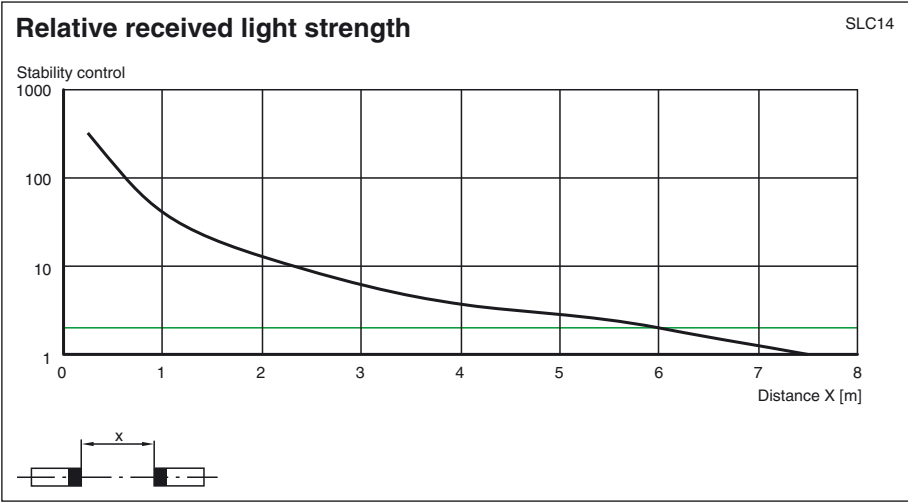
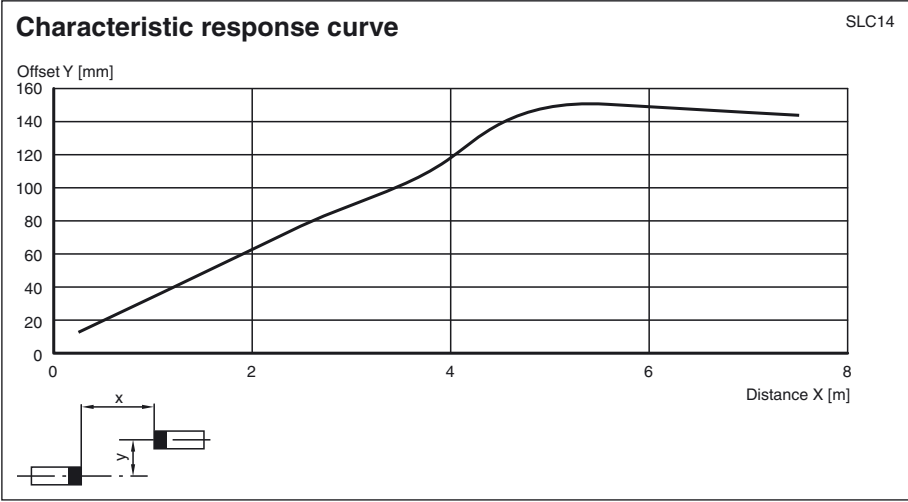

Release date: 2012-07-11 10:01 Date of issue: 2012-07-11 199736_eng.xml

Note

Master-Slave operation

- Master: SLC... (semiconductor)
or SLC.../31 (relay)
- Slave: SLC...-S

The use of slaves allows both the protection fields to be extended and protection fields to be created that do not all exist at a single level. When deciding which slaves to connect, remember that the total maximum of 96 beams must not be exceeded. Up to 192 beams are possible if the /130 option is selected.

Slaves exist for the transmitter and the receiver. These simply need to be connected to the master light curtain. Up to two slaves can be connected to both the transmitter and receiving units. Only one slave can be connected if the /130 option is selected.

Installation:

- 1 The end cap (no cable gland) on the light curtain is unscrewed and removed.
- 2 The plug-in jumper on the connectors of the now visible PCB is removed.
- 3 The slave is designed in such a way that the cap and PCB on the connecting cable plug directly onto the open end of the light curtain.
- 4 Once the end cap has been screwed on, the system is complete.

System accessories

- Mounting set SLC
- Test rods SLC14/SLC30/SLC60
- Protection glass for SLC (to protect the optical surface)
- Side cable gland SLC
- Profile alignment tool
- Beam alignment tool SLC
- Mirror for SLC (to protect danger areas on more than one side)
- Stands UC SLP/SLC
- Enclosure for stands
Enclosure UC SLP/SLC
- Start protection
Damping UC SLP/SLC