

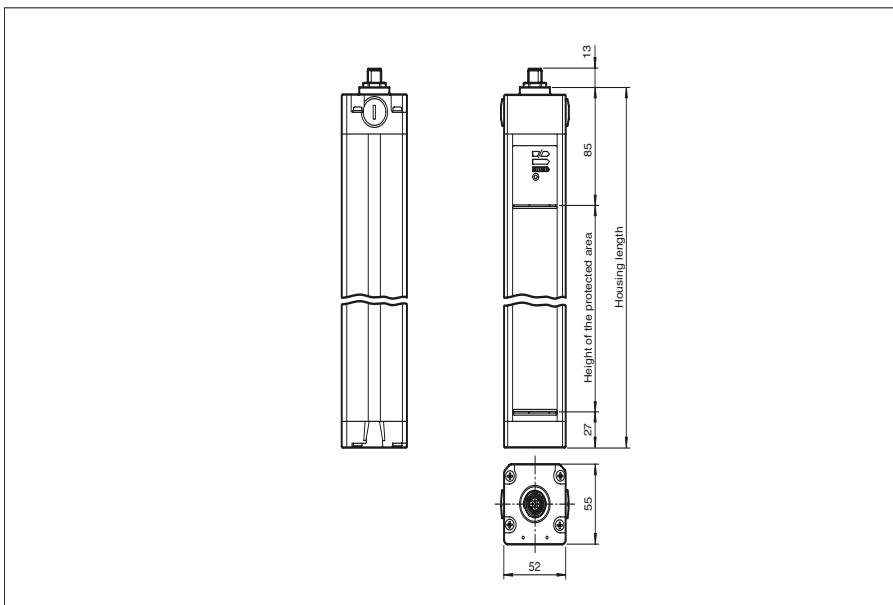

Dimensions



Model Number

SLC14-450/129/151
with 2 separate fail-safe semiconductor outputs

Features

- Sensing range up to 5 m
- Resolution 14 mm (finger protection)
- Self-monitoring (type 4 according to IEC/EN 61496-1)
- Master/Slave detection, Plug and Play
- Protection degree IP67
- Integrated function display
- Pre-fault indication
- Connection via appliance socket M12 x b1
- Safety outputs OSSD in potential-separated semiconductor version
- Protective field height up to 1800 mm
- Start/Restart disable preset by Option /129

Accessories

- PG SLC-450**
Protective glass panes for SLC series
- BA SLC**
laser alignment aid for safety light curtains series SLC

Electrical connection

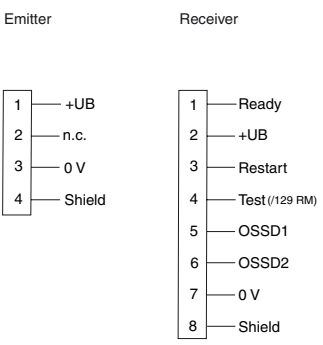

Pinout

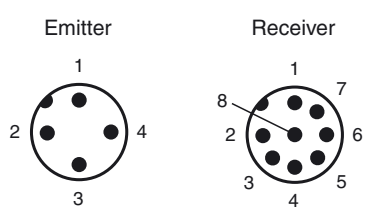

Release date: 2012-08-01 11:49 Date of issue: 2012-08-01 199723_eng.xml

Technical data**General specifications**

Effective detection range	0.2 ... 5 m
Light source	IREDD
Light type	modulated infrared light
Approvals	TÜV, cULus
Tests	IEC/EN 61496
Safety type according to IEC/EN 61496	4
Marking	CE
Width of protected area	0.2 ... 5 m
Protection field height	450 mm
Number of beams	48
Operating mode	can be selected with or without start/restart disable
Optical resolution	14 mm
Angle of divergence	< 5 °

Functional safety related parameters

Safety Integrity Level (SIL)	SIL 3
Performance level (PL)	PL e
Category	Cat. 4
Mission Time (T _M)	20 a
PFH _d	2.28 E-8
Type	4

Indicators/operating means

Operating display	7-segment display in emitter
Diagnostics display	7-segment display in receiver
Function display	in receiver: LED red: OSSD off LED green: OSSD on LED yellow: Protected area free, system start-ready
Pre-fault indication	LED orange
Controls	switch for start/restart disable, transmission coding

Electrical specifications

Operating voltage	U _B	24 V DC (-30 %/+25 %)
No-load supply current	I ₀	Emitter: ≤ 100 mA receiver: ≤ 150 mA
Protection class		III

Input

Activation current	approx. 10 mA
Activation time	0.03 ... 1 s
Test input	Reset-input for system test (not for option /129)
Function input	Start release

Output

Safety output	2 separated fail safe semiconductor outputs
Signal output	1 PNP, max. 100 mA for start readiness
Switching voltage	Operating voltage -2 V
Switching current	max. 0.5 A
Response time	18 ms

Ambient conditions

Ambient temperature	0 ... 55 °C (32 ... 131 °F)
Storage temperature	-25 ... 70 °C (-13 ... 158 °F)
Relative humidity	max. 95 %, not condensing

Mechanical specifications

Housing length L	560 mm
Protection degree	IP67
Connection	Emitter: M12 connector, 4-pin Receiver: M12 connector, 8-pin
Material	
Housing	extruded aluminum profile, RAL 1021 (yellow) coated
Optical face	Plastic pane
Mass	Per 1650 g

General information

System components	
Emitter	SLC14-450-T / 92
Receiver	SLC14-450-R / 129 / 151 Startup/restart disable preset

Compliance with standards and directives

Directive conformity	
Machinery Directive 2006/42/EC	EN ISO 13849-1:2008 EN 61496-1:2004/A1:2008
EMC Directive 2004/108/EC	EN 61000-6-4:2007 + A1:2011
Standard conformity	
Standards	IEC 61496-2:2006 EN 50178:1997

Approvals and certificates

CE conformity	CE
UL approval	cULus Listed
CCC approval	Products with a maximum operating voltage of ≤36 V do not bear a CCC marking because they do not require approval.
TÜV approval	TÜV

Curves/Diagrams

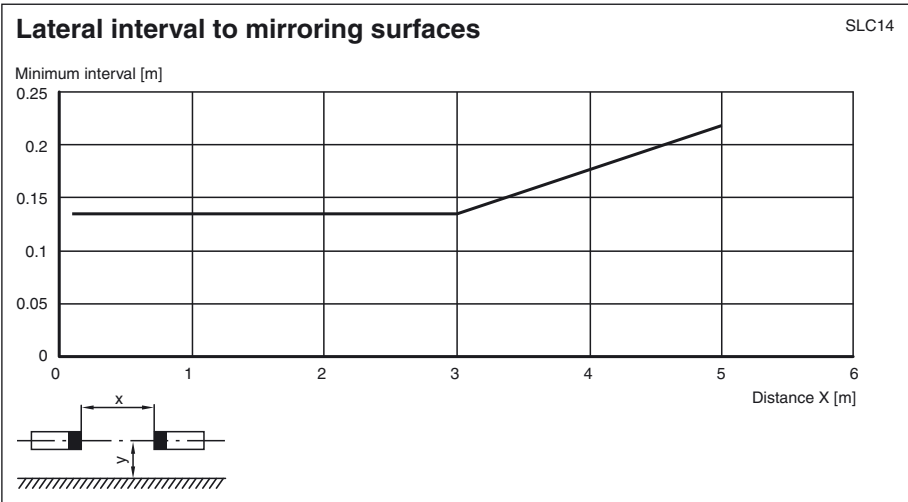
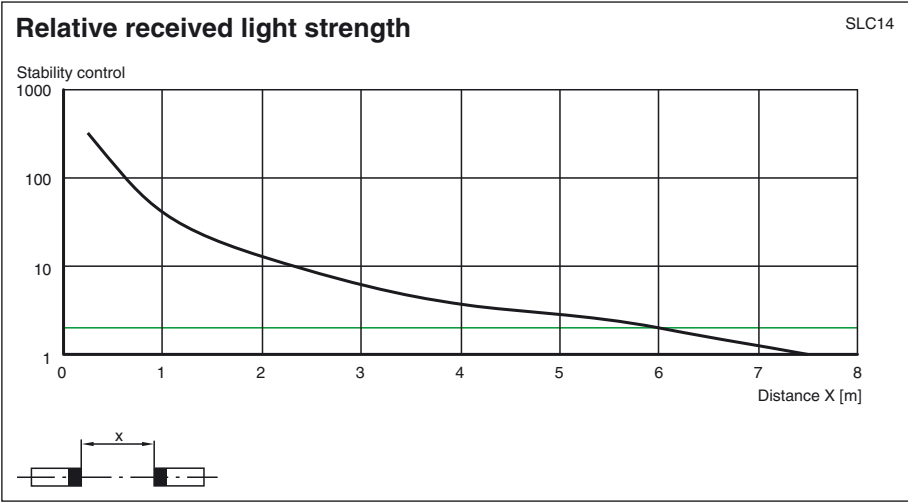
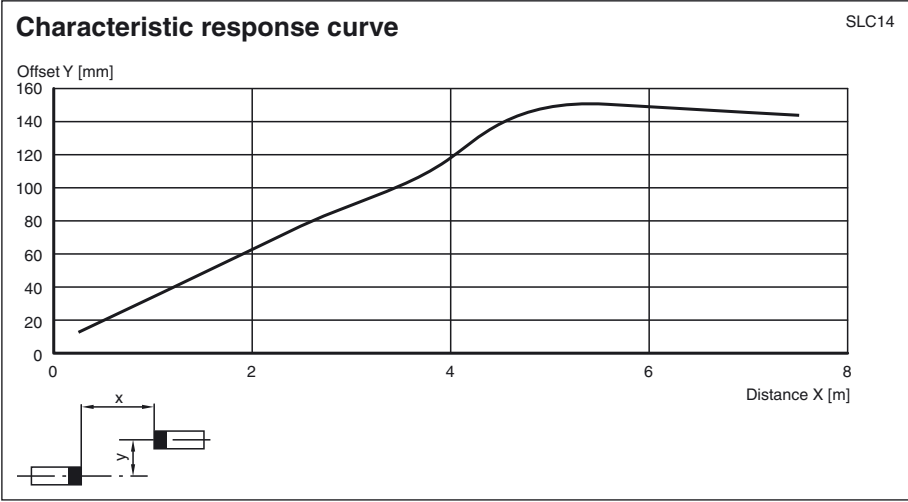

Release date: 2012-08-01 11:49 Date of issue: 2012-08-01 199723_eng.xml

Notes

Master slave mode

Master: SLC...-... (semiconductor)
or
SLC...-.../31 (relay)
Slave: SLC...-...-S

Using slaves makes it possible to lengthen protective fields or to form protective fields that lie in more than just one level. When you select slaves that can be connected, you should take into consideration that the maximum number of 96 light rays must not be exceeded.

There are slaves for transmitters and receivers. These may simply be connected to the master light curtain. As many as 2 slaves may be connected respectively to the transmitter and receiver unit.

Installation:

- 1 The end cap should be screwed off for the light curtain (without cable gland).
- 2 The plug-in jumper on the connectors of the printed circuit board, which is now visible, should be removed.
- 3 The slave is designed so that the cap located on the cable connector can be plugged directly onto the open end of the light curtain with the printed circuit board.
- 4 After you have screwed on the connection cap, the system is complete.

System accessories

- Mounting set SLC
- Test rods SLC14/SLC30/SLC60
- Protective glass pieces for SLC (to protect the optically functional surface)
- Lateral screwed connection SLC
- Profile alignment aid
- Laser alignment aid SLC
- Mirror for SLC (for securing hazardous areas on multiple sides)
- Ground pillar UC SLP/SLC
- Housing for pillar
Enclosure UC SLP/SLC
- Collision protector
Damping UC SLP/SLC