

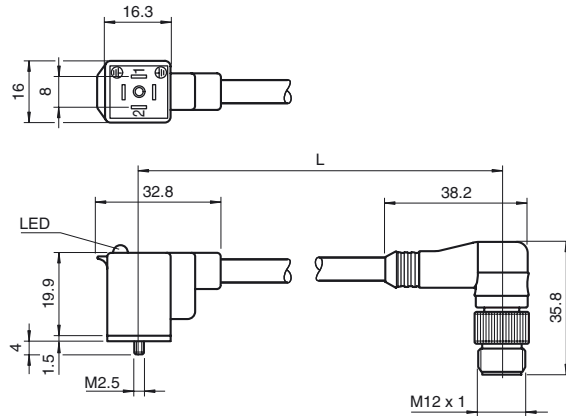

**Dimensions**



**Model Number**

**VMC-2+PE/LED/Z2-0,3M-PVC-V1-W**

Valve connector Form C on M12 circular connector with LED display

**Features**

- Valve connector according DIN 43650
- Built-in LED, as operating and function indicator

**Technical data**

**General specifications**

Number of pins	2 + PE
Connection 1	Valve connector DIN
Construction type 1	right angle
Connection 2	Male connector
Construction type 2	right angle
Threading 2	M12

**Indicators/operating means**

LED green	Operating display
-----------	-------------------

**Electrical specifications**

Operating voltage	$U_B$	24 V AC/DC
Operating current		max. 10 A

**Ambient conditions**

Ambient temperature	-5 ... 70 °C (23 ... 158 °F)
---------------------	------------------------------

**Mechanical specifications**

Protection degree	IP65	
Material		
Contacts	brass, silver-plated	
Body	PP	
Cable	PVC	
Core insulation	PVC	
Cable		
Sheath diameter	5.5 mm	
Color	black	
Cores	3 x 0.5 mm <sup>2</sup>	
Conductor construction	28 x 0.15 mm Ø	
Length	L	0.3 m

**Electrical connection**

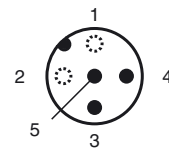
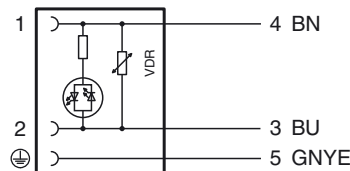

Release date: 2012-01-18 10:13 Date of issue: 2012-01-18 198914\_eng.xml