



Model Number

VMC-2+PE-0,3M-PVC-V1-W

Valve connector Form C on M12 circular connector

Features

- Valve connector according DIN 43650

Dimensions

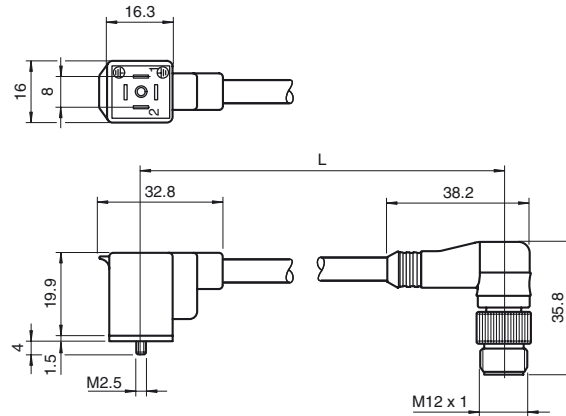

Technical data

General specifications

Number of pins	2 + PE
Connection 1	Valve connector DIN
Construction type 1	right angle
Connection 2	Male connector
Construction type 2	right angle
Threading 2	M12

Electrical specifications

Operating voltage	U_B	250 V AC/DC
Operating current		max. 10 A

Ambient conditions

Ambient temperature	-5 ... 70 °C (23 ... 158 °F)
---------------------	------------------------------

Mechanical specifications

Protection degree	IP65	
Material		
Contacts	brass, silver-plated	
Body	PP	
Cable	PVC	
Core insulation	PVC	
Cable		
Sheath diameter	5.5 mm	
Color	black	
Cores	3 x 0.5 mm ²	
Conductor construction	28 x 0.15 mm Ø	
Length	L	0.3 m

Electrical connection

