

Model Number

REF-H100-2R

Reflector, rectangular 100 mm x 100 mm, mounting holes

Features

- Mounting holes for simple installation
- Two reflectors per packaged unit

Dimensions

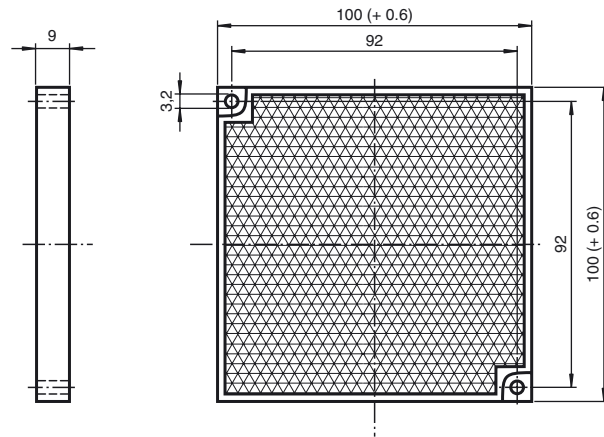

Technical data

General specifications

Construction type rectangular

Ambient conditions

Ambient temperature -20 ... 85 °C (-4 ... 185 °F)

Mechanical specifications

Material PMMA

Dimensions 100 mm x 100 mm x 9 mm

Mounting mounting holes