



Model Number

GLE30-RT/32/40a/98a

Photoelectric slot sensor with 3-pin, M8 x 1 connector

Features

- High switching frequency
- Optimized for the detection of small parts
- Visible red light
- Sensitivity adjuster and light/dark switch as standard features of this series
- Stainless steel housing
- Protection degree IP67
- cULus approval

Dimensions

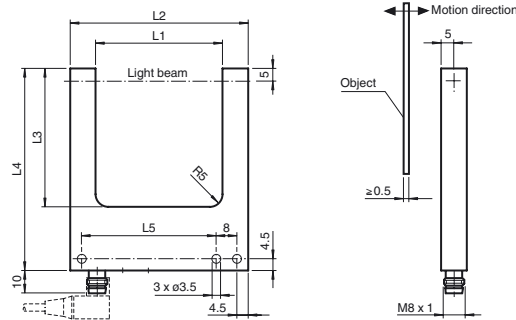

	L1	L2	L3	L4	L5
GL30...	30	50	35	60	33
GL50...	50	70	55	80	53
GL80...	80	100	55	80	83

Electrical connection

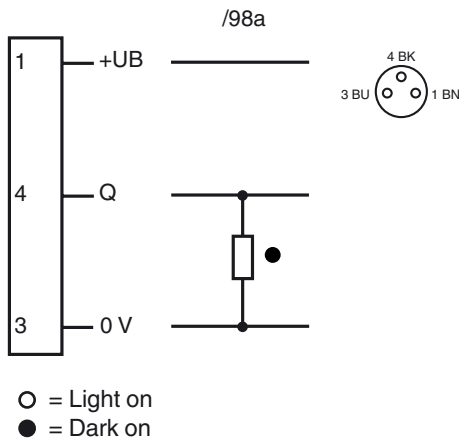

Pinout



Indicators/operating means

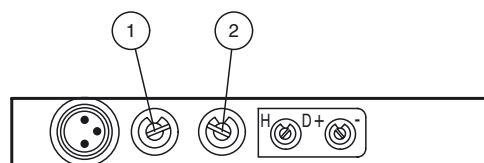

1	Light-/dark switch
2	Sensitivity adjuster

Release date: 2011-12-23 07:57 Date of issue: 2011-12-23 196655_eng.xml

Subject to modifications without notice

Pepperl+Fuchs Group
www.pepperl-fuchs.com

USA: +1 330 486 0001
fa-info@us.pepperl-fuchs.com

Germany: +49 621 776-4411
fa-info@pepperl-fuchs.com

Copyright Pepperl+Fuchs
Singapore: +65 6779 9091
fa-info@sg.pepperl-fuchs.com

Technical data**General specifications**

Light source	LED
Light type	modulated visible red light
Approvals	CE, cULus
Tests	EN 60947-5-2
Target size	0.5 mm
Fork width	30 mm
Ambient light limit	100000 Lux

Indicators/operating means

Function display	LED red in the connector plug, illuminates with free light beam
Controls	Sensitivity adjuster, light/dark switch

Electrical specifications

Operating voltage	U_B	10 ... 30 V DC, class 2
Ripple		10 %
No-load supply current	I_0	25 mA

Output

Switching type	light/dark on	
Signal output	1 PNP output, short-circuit protected, protected from reverse polarity, open collector	
Switching voltage	max. 30 V DC	
Switching current	max. 200 mA	
Switching frequency	f	350 Hz
Response time		1 ms

Ambient conditions

Ambient temperature	-20 ... 60 °C (-4 ... 140 °F)
Storage temperature	-20 ... 75 °C (-4 ... 167 °F)

Mechanical specifications

Protection degree	IP67
Connection	M8 connector, 3-pin
Material	
Housing	Stainless steel 1.4305 / AISI 303
Optical face	glass
Mass	80 g