



Laser Class II

Model Number

VB14A-100

Barcode scanner

Features

- Sturdy aluminium housing
- Protection degree IP65
- Engine control (On/Off) possible

Technical Data

General specifications

Approvals	CE, cULus
Laser class	2 -IEC825-1; class II - CDRH
Scan rate	800 ... 1000 s ⁻¹
Reading distance	45 ... 100 mm
Light type	semiconductor laser 630 ... 680 nm
Angle of divergence	50 °
Optical face	frontal
Resolution	0.2 mm (8 mils)

Indicators/operating means

Operating display	LED red: Power on (PWR/TxD) , LED green: Laser on (LASER ON), LED yellow: external trigger signal applied (EXT. TRIG.)
Data flow display	LED green flashing: Data transfer carried out (PWR/TxD)
Function display	LED red: signals the successful read-in of a barcode (GOOD READ)

Electrical specifications

Operating voltage	10 ... 30 V DC
Power consumption	P ₀ max. 3 W

Interface

Interface type	serial , RS 232 and RS 485 up to 115.2 kBit/s
----------------	---

Input 1

Input type	External triggering
------------	---------------------

Output

Signal output	2 Optocoupler
Switching voltage	max. 40 V DC
Switching current	max. 40 mA
Voltage drop	U _d 1 V at load current ≤ 10 mA

Standard conformity

Standards	EN 60947-5-2
-----------	--------------

Ambient conditions

Ambient temperature	0 ... 40 °C (273 ... 313 K)
Storage temperature	-20 ... 70 °C (253 ... 343 K)
Relative humidity	90 % , non-condensing
Shock resistance	IEC 68-2-27 Test EA 30G; 11 ms; 3 impacts on each axis
Vibration resistance	IEC 68-2-6 Test FC 1.5 mm ; 10 ... 55 Hz ; 2 hours on each axis

Mechanical specifications

Protection degree	IP65 according to DIN 40050
Connection	1 m connecting cable with 25-pin Sub-D connector
Material	
Housing	aluminium
Mass	330 g

Dimensions

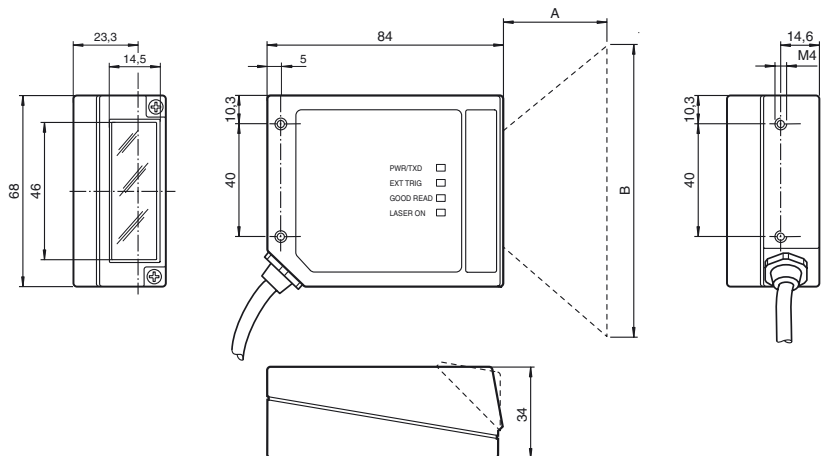

Mounting angle VB14

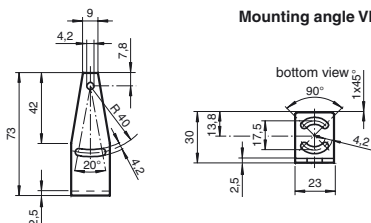

Electrical connection

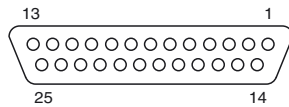

25-pin D-sub connector pinout

Pin	Name	Function		
13	10 V ... 30 V DC	Power supply input voltage +		
25	0 V	Power supply input voltage -		
1	CHASSIS	Chassis Ground		
9	10 V ... 30 V DC	Supply voltage +		
18	Ext. TRIG. +	External trigger +		
19	Ext. TRIG. -	External trigger -		
8	OUT1 +	Output 1+		
11	OUT2 +	Output 2+		
12	OUT REF.	Output reference		
22	OUT REF.	Output reference		
20	RX232	Aux. RX RS232		
21	TX232	Aux. TX RS232		
23	CTS232	Aux. handshake CTS RS232		
24	RTS232	Aux. handshake RTS RS232		
6, 10, 14, 15, 16, 17	NC	Not connected		
Pin		RS232	RS485 full-duplex	RS485 half-duplex
2	Main interface signals	TX232	TX485+	RTX485+
3		RX232	RX485+	-
4		RTS232	TX485-	RTX485-
5		CTS232	RX485-	
7		SGND	SGND	SGND

Curves / diagrams

Reading characteristics

VB14A-100

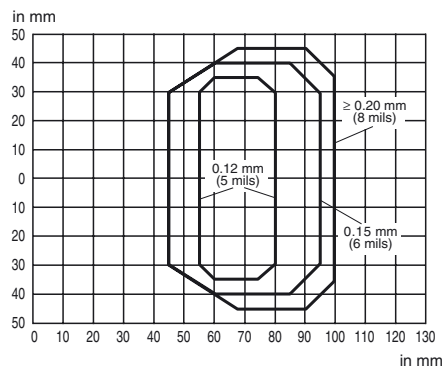

NOTE

(0.0) is the center of the laser beam output window.