



**Model Number**

**RL31-54/25/73c/136**

Retroreflective sensor  
with 4-pin, M12 x 1 connector

**Features**

- Compact and stable housing
- Glare protected with polarization filter
- Highly visible LED
- Powerful push-pull output
- Protection class II

**Dimensions**

Operating principle	color
Retroreflective sensor with polarisation filter	green
Retroreflective sensor	blue
Diffusive mode sensor	white
Thru-beam sensor	grey
Diffusive mode sensor with background suppression	red

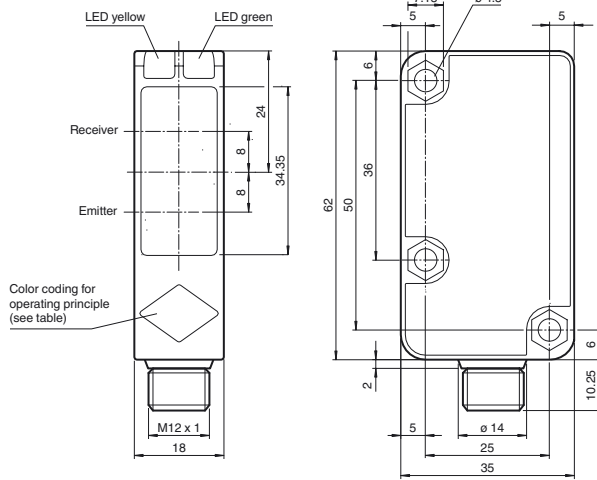
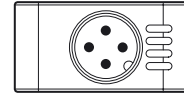

**Electrical connection**

Option:

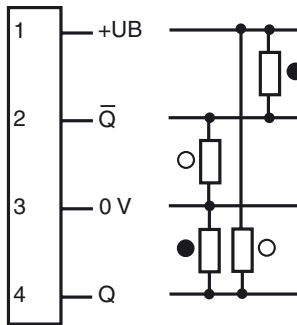

- = Light on
- = Dark on

**Pinout**

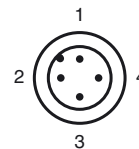

**Indicators/operating means**

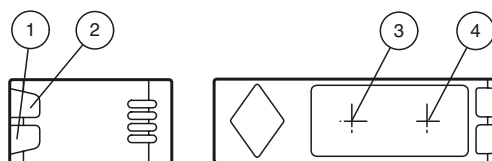

1	Operating display	green
2	Signal display	yellow
3	Emitter	
4	Receiver	

Release date: 2012-11-29 Date of issue: 2012-11-29 183810\_eng.xml

Subject to modifications without notice

Pepperl+Fuchs Group  
www.pepperl-fuchs.com

USA: +1 330 486 0001  
fa-info@us.pepperl-fuchs.com

Germany: +49 621 776-4411  
fa-info@pepperl-fuchs.com

Copyright Pepperl+Fuchs  
Singapore: +65 6779 9091  
fa-info@sg.pepperl-fuchs.com

**Technical data****General specifications**

Effective detection range	0 ... 9000 mm
Reflector distance	20 ... 9000 mm
Threshold detection range	12 m
Reference target	reflector C110-2
Light source	LED
Light type	modulated visible red light , 630 nm
Diameter of the light spot	approx. 200 mm at a distance of 6 m
Angle of divergence	3 °
Ambient light limit	50000 Lux ; according EN 60947-5-2

**Functional safety related parameters**

MTTF <sub>d</sub>	920 a
Mission Time (T <sub>M</sub> )	20 a
Diagnostic Coverage (DC)	0 %

**Indicators/operating means**

Operating display	LED green: power on
Function display	LED yellow: 1. LED lit constantly: signal > 2 x switching point (function reserve) 2. LED flashes: signal between 1 x switching point and 2 x switching point 3. LED off: signal < switching point

**Electrical specifications**

Operating voltage	U <sub>B</sub>	10 ... 30 V DC
Ripple		10 %
No-load supply current	I <sub>0</sub>	≤ 20 mA

**Output**

Switching type	light on	
Signal output	2 push-pull (4 in 1) outputs, short-circuit protected, reverse polarity protected	
Switching voltage	max. 30 V DC	
Switching current	max. 100 mA	
Voltage drop	U <sub>d</sub>	≤ 1.5 V
Switching frequency	f	≤ 500 Hz
Response time		≤ 1 ms

**Ambient conditions**

Ambient temperature	-30 ... 55 °C (-22 ... 131 °F)
Storage temperature	-40 ... 70 °C (-40 ... 158 °F)

**Mechanical specifications**

Protection degree	IP67
Connection	connector M12 x 1, 4-pin
Material	
Housing	plastic
Optical face	PMMA
Mass	24 g

**Compliance with standards and directives**

Directive conformity	EMC Directive 2004/108/EC
Standard conformity	
Product standard	EN 60947-5-2:2007 IEC 60947-5-2:2007

**Approvals and certificates**

Protection class	II , rated insulation voltage ≤ 250 V AC with pollution degree 1-2 according to IEC 60664-1 Output circuit basis insulation of input circuit according to EN 50178, rated insulation voltage 240 V AC
UL approval	cULus Listed, Class 2 Power Source, Type 1 enclosure
CCC approval	Products with a maximum operating voltage of ≤36 V do not bear a CCC marking because they do not require approval.

**Accessories**

**OMH-RL31-01**  
Mounting bracket

**OMH-RL31-02**  
Mounting bracket narrow

**OMH-RL31-03**  
Mounting bracket narrow

**OMH-RL31-04**  
Mounting aid for round steel ø 12 mm or sheet 1.5 mm ... 3 mm

**OMH-RL31-05**  
Mounting bracket with M10 threaded rod

**OMH-RL31-06**  
Stainless steel mounting bracket with adjustable half clamp on the side

**V1-G-2M-PUR**  
Cable socket, M12, 4-pin, PUR cable

**V1-W-2M-PUR**  
Cable socket, M12, 4-pin, PUR cable

Other suitable accessories can be found at [www.pepperl-fuchs.com](http://www.pepperl-fuchs.com)

**Curves/Diagrams**

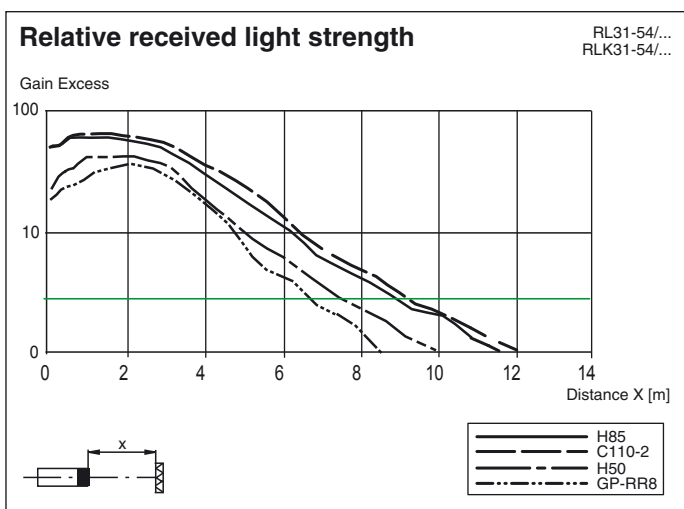
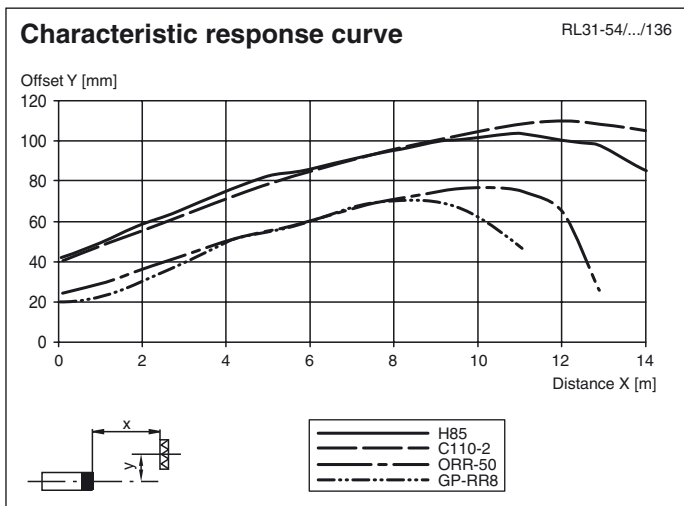

Release date: 2012-11-29 15:29 Date of issue: 2012-11-29 183810\_eng.xml