

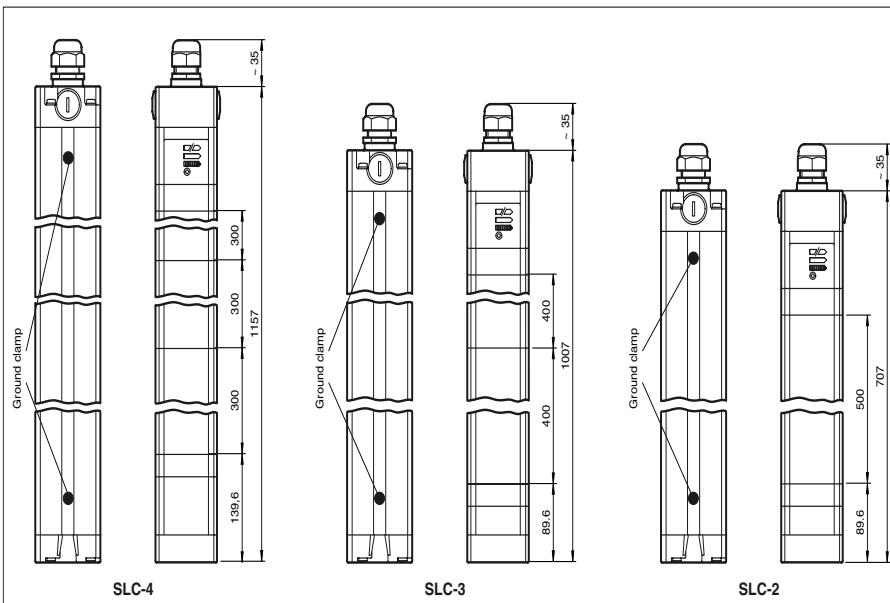

Dimensions



Model Number

SLC-2/133

Safety light grid with integrated control unit
with 2 separate fail-safe semiconductor outputs

Features

- ATEX-approval for zone 2 and zone 22
- Beam spacing 500 mm
- Self-monitoring (type 4 according to IEC/EN 61496-1)
- Safety outputs OSSD, external status displays OSSD
- Start/Restart disable
- 7-segment diagnostic display
- Pre-fault indication
- Protection degree IP66

Electrical connection

Emitter:

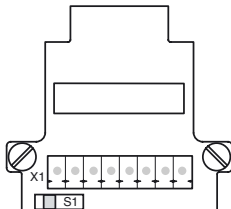

Receiver:

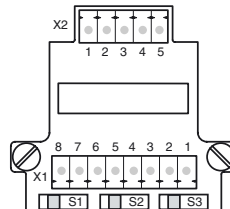

terminal	emitter	receiver (relay output)	receiver (semiconductor output)
X1.1	Functional earth	Functional earth	Functional earth
X1.2		test (input)	Test (input)
X1.3		OSSD2.2 (output)	0 V OSSD
X1.4		OSSD1.2 (output)	24 V OSSD
X1.5		OSSD2.1 (output)	OSSD2 (output)
X1.6		OSSD1.1 (output)	OSSD1 (output)
X1.7	0 V AC/DC	0 V AC/DC	0 V DC
X1.8	24 V AC/DC	24 V AC/DC	24 V DC
X2.1		Start release (output)	Start release (output)
X2.2		Status OSSD (output)	Status OSSD (output)
X2.3	not placed on board	24 V reference potential for I/O	n. c.
X2.4		0 V reference potential for I/O	n. c.
x2.5		Startup readiness (input)	Startup readiness (input)

Release date: 2012-07-11 09:59 Date of issue: 2012-08-07 133226_eng.xml

Technical data**System components**

Emitter	SLC-2-T/133
Receiver	SLC-2-R/133

General specifications

Effective detection range	0.2 ... 20 m
Light source	IRED
Light type	modulated infrared light
Safety type according to IEC/EN 61496	4
Target size	50 mm
Beam spacing	500 mm
Number of beams	2
Operating mode	can be selected with or without start/restart disable
Angle of divergence	< 5 °

Functional safety related parameters

Safety Integrity Level (SIL)	SIL 3
Performance level (PL)	PL e
Category	Cat. 4
Mission Time (T _M)	20 a
PFH _d	5.8 E-9
Type	4

Indicators/operating means

Operating display	7-segment display in emitter
Diagnostics display	7-segment display in receiver
Function display	in receiver: LED red: OSSD off LED green: OSSD on LED yellow: Protected area free, system start-ready
Pre-fault indication	LED orange
Controls	switch for start/restart disable, transmission coding

Electrical specifications

Operating voltage	U _B	24 V DC (-30 %/+25 %)
No-load supply current	I ₀	Emitter: 100 mA , receiver 150 mA
Protection class		III

Input

Activation current	approx. 10 mA
Activation time	0.03 ... 1 s
Test input	Reset-input for system test
Function input	Start release

Output

Safety output	2 separated fail safe semiconductor outputs
Signal output	1 PNP, max. 100 mA for start readiness , short-circuit protected 1 PNP, max. 100 mA for OSSD status , short-circuit protected
Switching voltage	Operating voltage -2 V
Switching current	max. 0.5 A
Response time	10 ms

Ambient conditions

Ambient temperature	0 ... 55 °C (32 ... 131 °F)
Storage temperature	-25 ... 70 °C (-13 ... 158 °F)
Relative humidity	max. 95 %, not condensing

Mechanical specifications

Protection degree	IP66
Connection	M20 cable gland , Cable diameter Ø5.5 ... 13 mm , terminal compartment with screw terminals, lead cross-section max. 1.5 mm ²
Material	
Housing	extruded aluminum profile, RAL 1021 (yellow) coated
Optical face	Plastic pane
Mass	Per 2100 g

General information

System components	
Emitter	SLC-2-T/133
Receiver	SLC-2-R/133
Use in the hazardous area	see more details for the use in hazardous areas
Category	3G; 3D

Compliance with standards and directives

Directive conformity	
Machinery Directive 2006/42/EC	EN ISO 13849-1:2008 EN 61496-1:2004/A1:2008
EMC Directive 2004/108/EC	EN 61000-6-4:2007 + A1:2011
Standard conformity	
Standards	IEC 61496-2:2006 EN 50178:1997

Approvals and certificates

CE conformity	CE
CCC approval	Products with a maximum operating voltage of ≤36 V do not bear a CCC marking because they do not require approval.

TÜV approval

TÜV

ATEX 3G (nA)

Instruction

Device category 3G (nA)

Directive conformity

Standard conformity

Ex-identification

Installation, Commissioning

Maintenance

Special conditions

Maximum permissible ambient temperature T_{Umax}

Protection from mechanical danger

Protection from UV light

Electrostatic charging

Protection of overvoltage

Other conditions

Manual electrical apparatus for hazardous areas

for use in hazardous areas with gas, vapour and mist

94/9/EG

EN 60079-0:2009 , EN 60079-15:2010 , EN 60079-28:2007

. II 3 G Ex nAc op is IIC T4

Laws and/or regulations and standards governing the use or intended usage goal must be observed. By fitting a suitable external fixture, the connecting cable is secured against the transmission of rotational movements and tensile loading on the connections. After opening the enclosure (connection cap) and connecting the wires, but before mounting the connection cap, ensure the seal is correctly fitted and intact. Damaged seals are to be replaced.

No modifications must be undertaken on apparatus, which is operated in hazardous areas. Repairs to such apparatus are not permissible.

55 °C (131 °F)

The cable and wire gland and end caps are to be protected from mechanical shock.

The sensor must be protected against harmful UV radiation. This can be achieved by using the sensor indoors.

The enclosure is to be grounded with help of the accompanying grounding terminal EC SLC EX via a wire with a cross section of 4 mm².

Precautions must be taken to prevent the rated voltage being exceeded by more than 40 % due to transient disturbances.

Do not open or disconnect when energized! By fitting a suitable external fixture, the connecting cable is secured against the transmission of rotational movements and tensile loading on the connections. After opening the enclosure (connection cap) and connecting the wires, but before mounting the connection cap, ensure the seal is correctly fitted and intact. Damaged seals are to be replaced.

ATEX 3D

Instruction

Details for use in hazardous areas

Directive conformity

Standard conformity

Ex-identification

Installation, Commissioning

Maintenance

Special conditions

Protection from mechanical danger

Protection from UV light

Electrostatic charging

Protection of overvoltage

Manual electrical apparatus for hazardous areas

Electrical apparatus for potentially explosive atmospheres

94/9/EG

EN 60079-31:2009

. II 3 D Ex tc IIIC T90 °C

Laws and/or regulations and standards governing the use or intended usage goal must be observed. By fitting a suitable external fixture, the connecting cable is secured against the transmission of rotational movements and tensile loading on the connections. After opening the enclosure (connection cap) and connecting the wires, but before mounting the connection cap, ensure the seal is correctly fitted and intact. Damaged seals are to be replaced.

No modifications must be undertaken on apparatus, which is operated in hazardous areas. Repairs to such apparatus are not permissible.

The cable and wire gland and end caps are to be protected from mechanical shock.

The sensor must be protected against harmful UV radiation. This can be achieved by using the sensor indoors.

The enclosure is to be grounded with help of the accompanying grounding terminal EC SLC EX via a wire with a cross section of 4 mm².

Precautions must be taken to prevent the rated voltage being exceeded by more than 40 % due to transient disturbances.

Curves/Diagrams

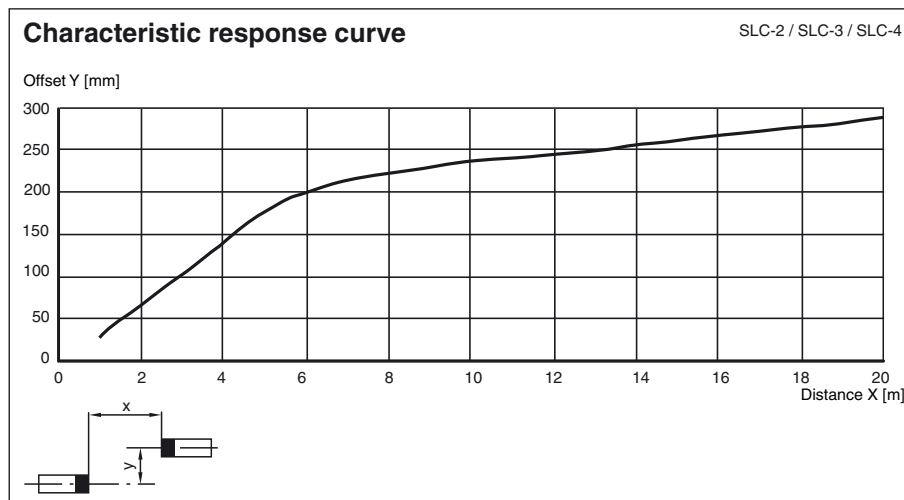

Release date: 2012-07-11 09:59 Date of issue: 2012-08-07 133226_eng.xml

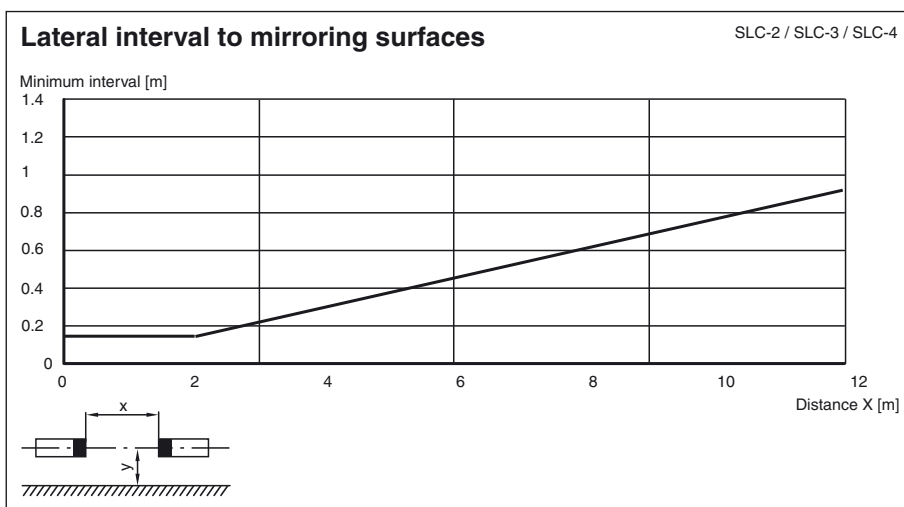
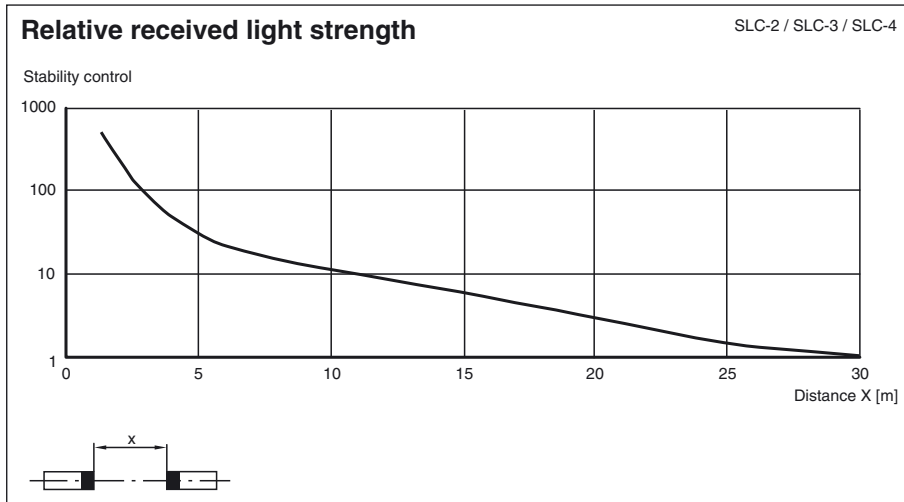

Additional information

Profile dimensions, front view

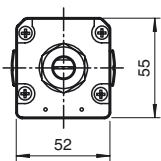

System accessories

- Mounting set SLC
- Protective glass pieces for SLC (to protect the optically functional surface)
- Lateral screwed connection SLC
- Mirror 2, 3 or 4-beam for SLC (for multi-side securing of hazardous areas)
- Laser alignment aid BA SLC
- Profile alignment aid PA SLP/SLC
- Ground pillar UC SLP/SLC
- Housing for ground pillar Enclosure UC SLP/SLC
- Collision protector Damping UC SLP/SLC

Release date: 2012-07-11 09:59 Date of issue: 2012-08-07 133226_eng.xml