



Model Number

SL3025-X2/GS130

Cable pull

Features

- **Direct length and position measurement**
- **High accuracy of measurement**
- **Simple installation**
- **Sturdy construction**
- **Long lifetime**

Description

The combination of a multiturn absolute rotary encoder and a cable pull is ideal for positioning applications where easy installation and low costs are required.

Pepperl+Fuchs cable pulls incorporate a high precision measuring drum with extremely robust spring return, around which a highly flexible stainless steel is wound. The rotary movement of the measuring drum is transferred to the flanged multiturn absolute rotary encoder via a play-free coupling.

Technical data

General specifications

Measuring range	25000 mm
Travel speed	max. 4 m/s
Acceleration	max. 30 m/s ²
Drum perimeter	334.1 mm
Linearity error	typ. 0.1 % / 0.5 %
Resolution	334.1 mm / steps per revolution of mounted encoder

Ambient conditions

Ambient temperature	-30 ... 70 °C (-22 ... 158 °F)
Shock resistance	25 g

Mechanical specifications

Shaft dimensions Ø x l	10 mm x 20 mm , clamping flange
Rope diameter	1.35 mm
Tension force at rope	10 ... 21 N
Protection degree	IP65

Material

Housing	anodized aluminium
Rope	Stainless steel 1.4401/316
Mass	7500 g

Dimensions

A	215.4 mm
B	384.1 mm
C	215.4 mm
D	80 mm
E	130 mm
F	approx. 60 mm
G	52 mm
L _F	34.8 mm
M	M8 x 8
Life span	10 ⁶ Cycles

General information

Scope of delivery	Cable pull , Coupling
-------------------	-----------------------

Dimensions

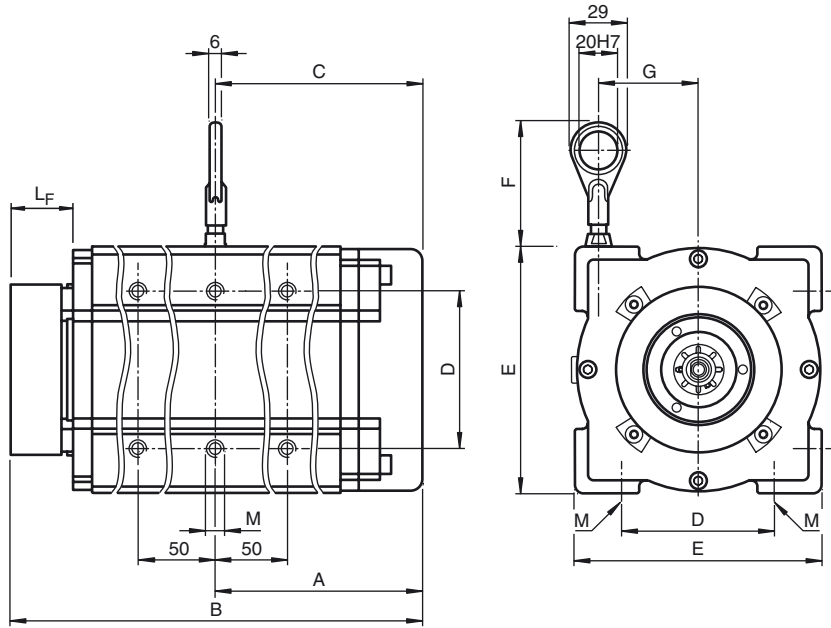

Accessories

SL-RP/GS130/GS190

Guide pulley for cable pulls SL30.../GS130 and SL30.../GS190

Order Code

S	L	3	0		-		/	G	S		
---	---	---	---	--	---	--	---	---	---	--	--

Options (can be combined)

- /F with rubber gaiter
- /DF with double spring assembly
- /HC with hard coating

Housing width / housing height [mm]

- 80** 80 mm x 80 mm (up to 3 m cable length)
- 130** 130 mm x 130 mm (5 m ... 30 m cable length)
- 190** 190 mm x 190 mm (from 40 m cable length)

Encoder shaft / encoder flange

- X1** solid shaft \varnothing 6 mm x 10 mm, synchro flange
- X2** solid shaft \varnothing 10 mm x 20 mm, clamping flange

Cable length

- 01** 1 m
- 02** 2 m
- 03** 3 m
- 05** 5 m
- 10** 10 m
- 15** 15 m
- 20** 20 m
- 25** 25 m
- 30** 30 m
- 40** 40 m
- 50** 50 m

Example:

SL3001-X1/GS80/F/DF/HC

Cable pull, series 30