



Model Number

RL28-55-LAS/47/82b/105

Retroreflective sensor
with 5-pin, M12 x 1 plastic connector

Features

- Visible red light, pulsed LASER light
- Ultra bright LEDs for power on, pre fault indication and switching state
- Not sensitive to ambient light, even with switched energy saving lamps
- Protection class II
- Waterproof, protection degree IP67

Dimensions

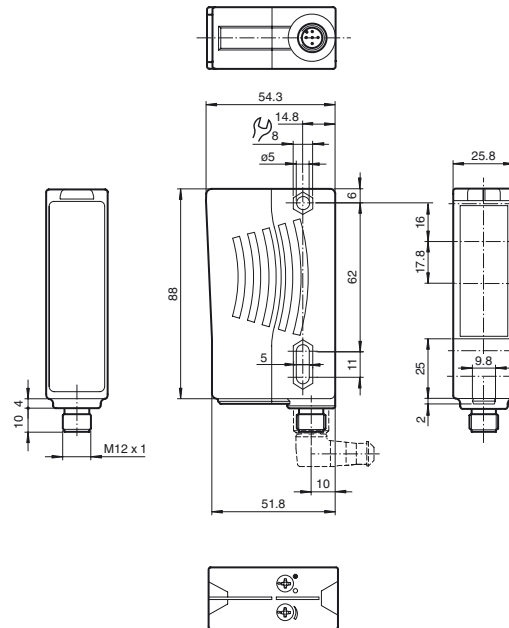

CLASS 1 LASER PRODUCT
IEC 60825-1:2007 certified.
Complies with 21 CFR 1040.10 and 1040.11 except for deviations pursuant to Laser Notice No. 50, dated June 24, 2007.

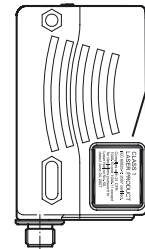

Electrical connection

Option: /47/82b

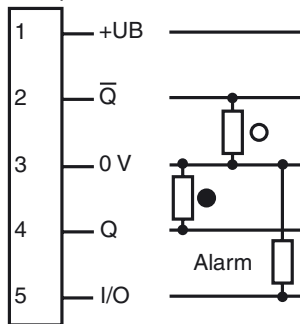

- = Light on
- = Dark on

Pinout

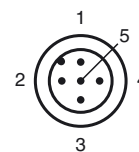

Indicators/operating means

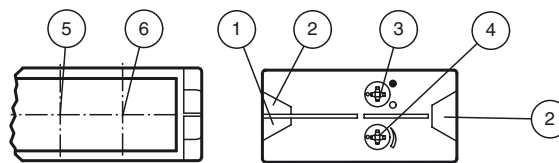

1	Operating display green
2	Switch state yellow
3	Bright/dark switch
4	Sensitivity adjustment
5	Receiver
6	Emitter

Release date: 2011-12-21 10:26 Date of issue: 2011-12-21 123760_eng.xml

Subject to modifications without notice

Pepperl+Fuchs Group
www.pepperl-fuchs.com

USA: +1 330 486 0001
fa-info@us.pepperl-fuchs.com

Germany: +49 621 776-4411
fa-info@pepperl-fuchs.com

Copyright Pepperl+Fuchs
Singapore: +65 6779 9091
fa-info@sg.pepperl-fuchs.com

Technical data**General specifications**

Effective detection range	0 ... 30 m
Reflector distance	0.3 ... 30 m
Threshold detection range	42 m
Reference target	MH82 reflector
Light source	laser diode
Light type	modulated visible red light
Laser nominal ratings	
Note	LASER LIGHT , DO NOT STARE INTO BEAM
Laser class	1
Wave length	650 nm
Beam divergence	< 1.5 mrad
Pulse length	approx. 4.5 μ s
Repetition rate	approx. 6 kHz ... 20 kHz
max. pulse energy	4 nJ
Approvals	CE, cULus
Diameter of the light spot	approx. 45 mm at 30 m
Angle of divergence	Emitter: < 0.1 ° Receiver: < 2 °
Ambient light limit	50000 Lux

Functional safety related parameters

MTTF _d	1000 a
Mission Time (T _M)	20 a
Diagnostic Coverage (DC)	0 %

Indicators/operating means

Operating display	LED green
Function display	2 LEDs yellow, light up when light beam is free, flash when falling short of the stability control, off when light beam is interrupted
Controls	sensitivity adjustment (Adjustment to < 25% of the effective operating range) , Light/Dark switch

Electrical specifications

Operating voltage	U _B	10 ... 30 V DC
Ripple		max. 10 %
No-load supply current	I ₀	≤ 35 mA
Protection class		II, rated insulation voltage ≤ 250 V AC with pollution degree 1-2 according to IEC 60664-1

Output

Output of the pre-fault indication	1 PNP, inactive when falling short of the stability control for 10;s immediately inactive if 4 light beam interruptions take place	
Switching type	light/dark on switchable	
Signal output	2 PNP, complementary, short-circuit protected, reverse polarity protected , open collectors	
Switching voltage	max. 30 V DC	
Switching current	max. 200 mA	
Voltage drop	U _d	≤ 2.5 V DC
Switching frequency	f	1000 Hz
Response time		0.5 ms

Ambient conditions

Ambient temperature	-10 ... 50 °C (14 ... 122 °F)
Storage temperature	-20 ... 75 °C (-4 ... 167 °F)

Mechanical specifications

Protection degree	IP67
Connection	5-pin, M12 x 1 plastic connector
Material	
Housing	Plastic ABS
Optical face	Plastic pane
Mass	80 g

Compliance with standards and directives

Directive conformity	EMC Directive 2004/108/EC
Standard conformity	
Product standard	EN 60947-5-2:2007 IEC 60947-5-2:2007
Laser class	IEC 60825-1:2007 Complies with 21 CFR 1040.10 and 1040.11 except for deviations pursuant to Laser Notice No. 50, dated June 24, 2007

Approvals and certificates

CCC approval	Products with a maximum operating voltage of ≤36 V do not bear a CCC marking because they do not require approval.
--------------	--

Accessories**OMH-05**

Mounting aid for round steel \varnothing 12 mm or sheet 1.5 mm ... 3 mm

OMH-07

Mounting aid for round steel \varnothing 12 mm or sheet 1.5 mm ... 3 mm

OMH-21

Mounting bracket

OMH-22

Mounting bracket

OMH-RLK29

Mounting bracket

OMH-MLV11-K

dove tail mounting clamp

OMH-RLK29-HW

Mounting bracket for rear wall mounting

OMH-RL28-C

Protective cover

REF-MH82

Reflector with Micro-structure, rectangular 82 mm x 60 mm, mounting holes

Other suitable accessories can be found at www.pepperl-fuchs.com

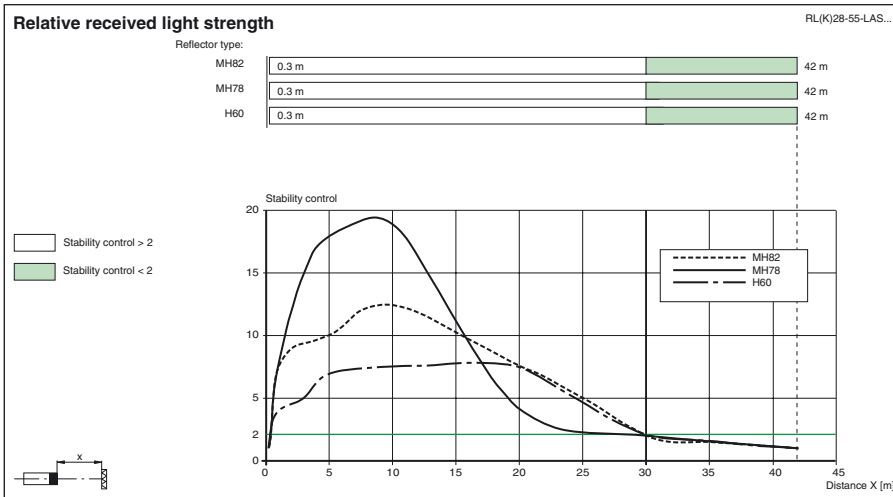

Curves/Diagrams

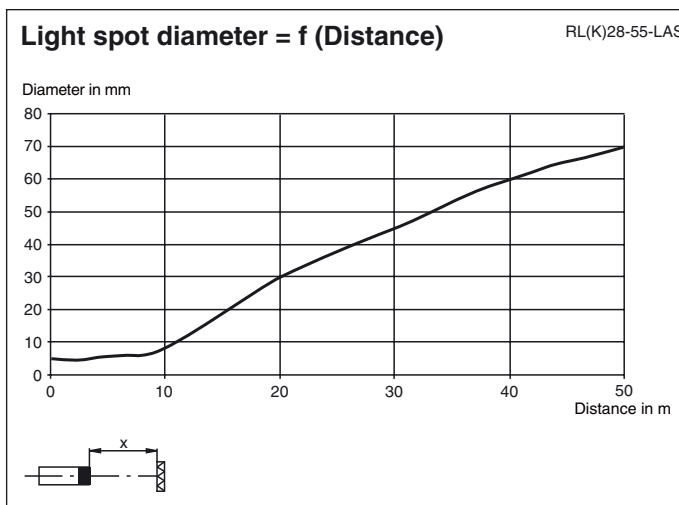

Laser notice laser class 1

- The irradiation can lead to irritation especially in a dark environment. Do not point at people!
- Maintenance and repairs should only be carried out by authorized service personnel!
- Attach the device so that the warning is clearly visible and readable.
- Caution – Use of controls or adjustments or performance of procedures other than those specified herein may result in hazardous radiation exposure.

Release date: 2011-12-21 10:26 Date of issue: 2011-12-21 123760_eng.xml