



### Model Number

PLVScanP40-1660-42-2604/32/139

Light grid  
with connector

### Features

- Light grid for profile monitoring
- Beam spacing 42.5 mm
- Separate outputs for height monitoring
- Adjustable beam crossover and emitted optical power
- Programmable via Windows software
- Test input

### Dimensions

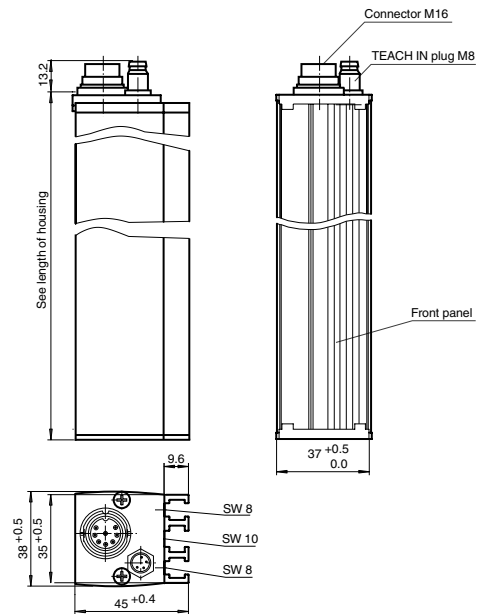

### Electrical connection

Emitter

Receiver

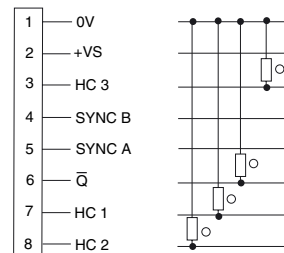
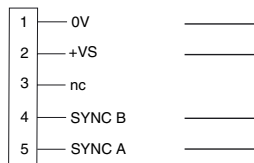

○ = Light on  
● = Dark on

**Technical data****General specifications**

Effective detection range	1.5 ... 4 m
Threshold detection range	6 m
Sensing range	0 ... 4000 mm
Light source	IREDD
Light type	modulated infrared light
Field height	1660 mm
Chipping	5X
Beam spacing	42.5 mm
Number of beams	40
Angle of divergence	Emitter: $\pm 15^\circ$ , Receiver: $\pm 10^\circ$
Ambient light limit	50000 Lux

**Indicators/operating means**

Operating display	LED green
Function display	Emitter: LED yellow, light with free light beam, off when falling short of the function reserve, Receiver: LED yellow: flashes when the beam field is interrupted, otherwise off

**Electrical specifications**

Operating voltage	$U_B$	15 ... 30 V DC
Ripple		10 %
Power consumption	$P_0$	max. 7 W

**Interface**

Interface type	RS 232
----------------	--------

**Input**

Test input	emitter deactivation at $+U_B$
Function input	RS 232 interface for system programming

**Output**

Switching type	light on	
Signal output	1 PNP, short-circuit protected (monitoring field), 3 PNP, short-circuit protected, light on (height monitoring)	
Switching voltage	30 V DC	
Switching current	200 mA	
Switching frequency	f	8 Hz
Response time	60 ms for triple beam crossing	
Timer function	Off-delay programmable from 0 ... 1.25 s in 5 ms steps	

**Ambient conditions**

Ambient temperature	-10 ... 60 °C (14 ... 140 °F) In North America: -10 ... 40 °C (14 ... 104 °F)
Storage temperature	-20 ... 70 °C (-4 ... 158 °F)

**Mechanical specifications**

Housing length L	1747 mm
Protection degree	IP50
Connection	Emitter: 5-pin, M16 connector, Receiver: 8-pin, M16 connector
Material	
Housing	silver-anodized aluminum
Optical face	PMMA
Mass	2300 g (device)

**Compliance with standards and directives**

Standard conformity	
Product standard	EN 60947-5-2:2007 IEC 60947-5-2:2007

**Approvals and certificates**

CE conformity	yes
UL approval	cULus
CCC approval	Products with a maximum operating voltage of $\leq 36$ V do not bear a CCC marking because they do not require approval.

Additional accessories can be found in the Internet.

## Curves/Diagrams

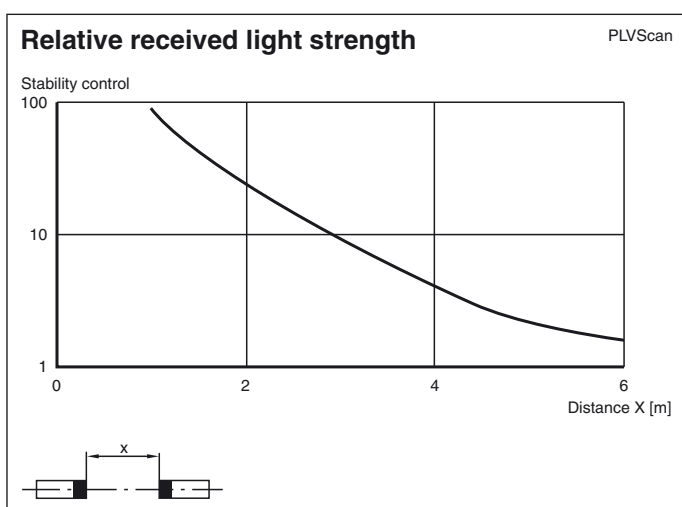
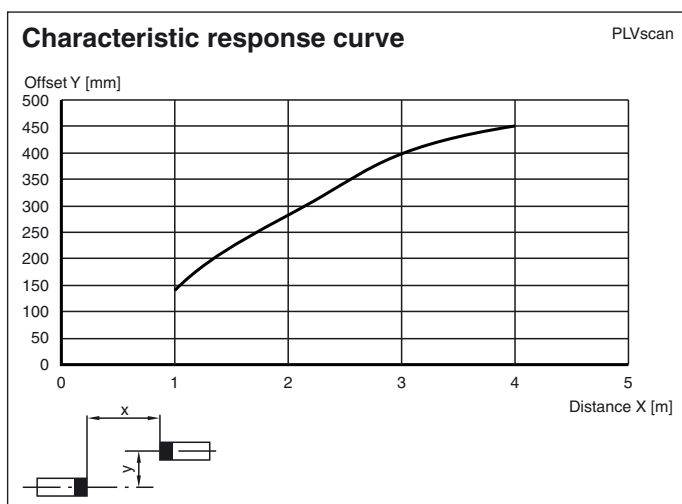

## Arrangement and function

### Principle of operation

Light grids consist of an emitter bar and a receiver bar. The surface to be monitored is in between the two. The switching command is initiated by a body or object penetrating into the monitoring field.

The light grid PLVScan ensures an overall monitoring of the evaluation range with a max. of 64 light beams (infrared emitter and receiver). The integrated signal processing saves an additional mounting of a separate controlgear. Due to the modular design of the system, different distances of the light beams can be implemented. This makes it possible to use the light grids of the PLVScan series optimally and adapt them specifically to a given application.

In addition the system is equipped with up to four switch outputs which can be used for height monitoring (option /39) or with a serial data output across which the state of the beams can be queried(option /86). The system programming is accomplished via a RS 232 interface. For this purpose, the software WINPLV is required which can be ordered separately.

### Safety Instructions:

The device must only be operated with an extra-low safety voltage with safe electrical separation. Only your supplier is authorised to make repairs or changes to the device!

The system must be regularly maintained and monitored. The programming cable can only be plugged in when the light grid is turned on and working correctly.

A clean, soft cloth can be used for cleaning. Aggressive, abrasive and scratching cleaners that could scour or damage the surface must be avoided. The device must not be exposed to strong jolts or vibrations.

### Commissioning

Preconditions:

- The emitter and receiver bars must be correctly mounted and aligned.
- The electrical connection must have been set up according to the connection diagram.  
**Important:** The sync lines must be connected to each other (A to A) and (B to B).
- The signal output responds to object detection or heavy accumulation of dirt and dust on the transparent outline covering.
- In the case of interruption of at least one light beam, the output remains active as long as the object or the soiling is detected.

**ATTENTION!**

Supply +UB / GND(0 V)

Connection is reverse-polarity protected. If the housing of the PLVScan is earthed and the operating voltage is reverse polarity protected, a short circuit current can flow through both housings to earth. If polarity is reversed and the light grid is earthed, components in the device may be destroyed as a result.

**Error detection**

- Measuring the operating voltage
- Control of the wiring (sync leads connected?) .
- Control of emitter- and receiver bar for soiling effects, cleaning, if necessary.

**LED functional displays**

A green LED for function display of Power ON and a yellow Status LED with a diagnostic function are located on the connection side of the profiles behind the optical system covering.

In normal operation, the yellow LED in the transmitter is continuously lit if there is sufficient functional reserve.

The yellow LED in the receiver indicates the switching state of the light grid.

**Diagnostic function of the yellow LED**

Function	Diagnostic description
The LED of the transmitter is lit statically The LED of the receiver is not lit	Normal status with free protected area, system is active, all light lines are free and have sufficient function reserve.
LED of the emitter flashes slowly (approx. 0.5 Hz)	Insufficient function reserve because of poor alignment of the light grid, receiver or RS485 bus is incorrectly connected.
LED of the receiver not lit, output protected area active	Transmitter or RS bus connected incorrectly.
LED on the receiver is flashing (approx. 1 Hz) output protected area active	at least one light line is covered.
LED on the receiver is flashing (approx. 2 Hz)	The system is in test mode and the programming connector is plugged in.
LED on the receiver is flashing quickly (about 7 Hz)	No valid values in EEPROM or the system is not programmed $\Rightarrow$ Ρε-προγραμ.
LED of the receiver flashes continuously	The system is in programming mode.

**Resolution and beam spacing**

The mechanical beam spacing (see illustration, dimension X) determines the smallest size of object that can still be detected. The resolution of the light grid can be increased by crossing light beams. The detection ranges can be adjusted on the transmission unit with a potentiometer.

The units are delivered without any programming for height monitoring. The course of the beam is not crossed.

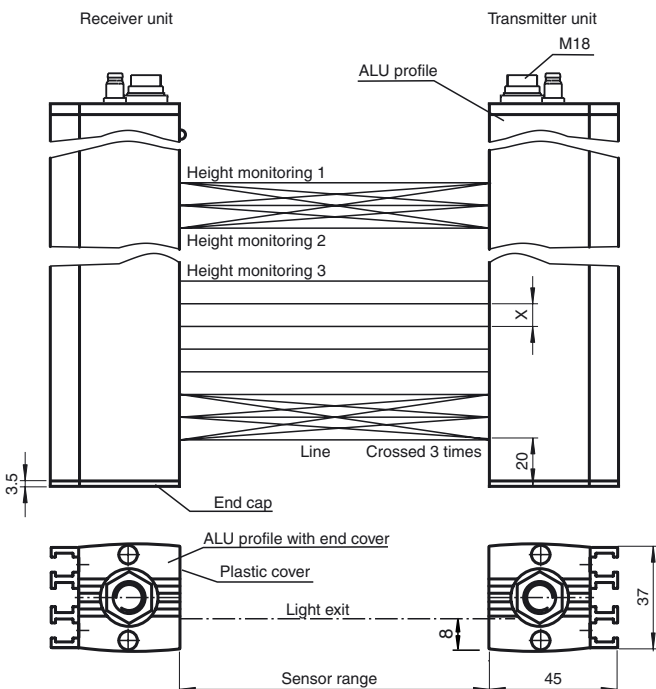

Representation of the course of the beam as straight/crossed, design example with three light lines for height monitoring

## Resolution of the crossed beam arrangement

### Triple crossing

If a triple crossing of beams is programmed, the resolution is increased. For a triple crossing this means that the increased resolution is available after 25% of the transmitter or receiver distance RW. You must therefore ensure that all objects fit with the transmitter or receiver with a distance of this magnitude.

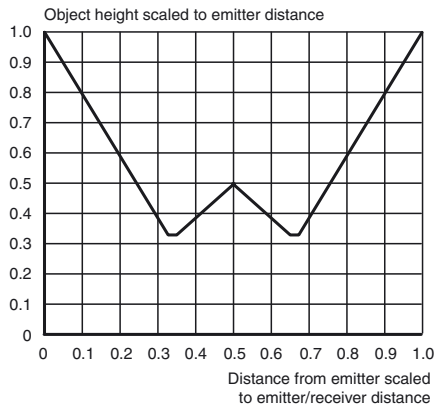

### Five-fold crossing

If a five-fold crossing of beams is programmed, the resolution is increased. For a 5-fold crossing, this means that the increased resolution is available after 15% of the transmitter or receiver distance RW. You must therefore ensure that all objects fit with the transmitter or receiver with a distance of this magnitude.

