



**Model Number**

**SLC60-1800-S**

Slave module for master slave mode

**Features**

- Sensing range up to 15 m
- Resolution 60 mm
- Protective field height up to 1800 mm
- Self-monitoring (type 4 according to IEC/EN 61496-1)
- Master/Slave detection, Plug and Play
- Start/Restart disable
- Protection degree IP67
- Integrated function display
- Pre-fault indication
- Safety outputs OSSD in potential-separated semiconductor design or with monitored, compelled connection NC-contacts
- Optional with ATEX certificates for zone 2 and 22 and protection degree IP66 (Option 133)

**Accessories**

**PG SLC-1800**  
Protective glass panes for SLC series

**BA SLC**  
laser alignment aid for safety light curtains series SLC

**Dimensions**

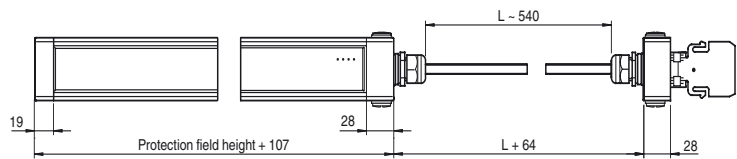

**Electrical connection**

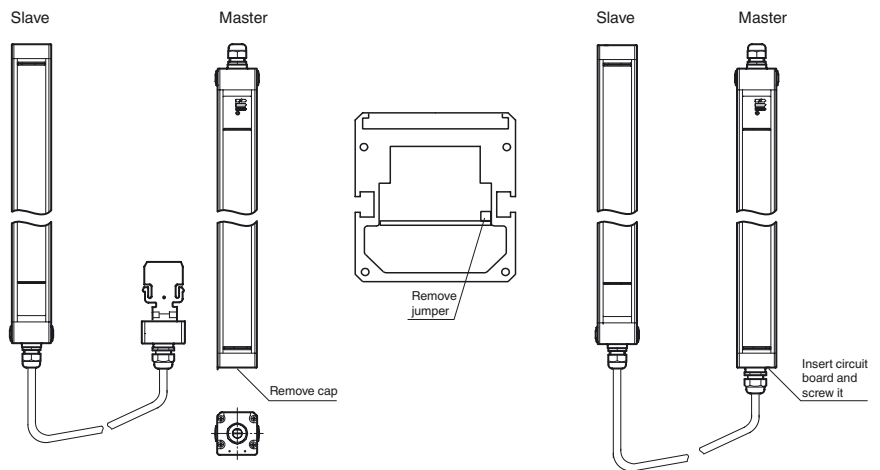

Release date: 2012-08-01 12:24 Date of issue: 2012-08-01 117614\_eng.xml

**Technical data****General specifications**

Effective detection range	0.2 ... 15 m
Light source	IREC
Light type	modulated infrared light
Approvals	TÜV, UL
Tests	IEC/EN 61496
Safety type according to IEC/EN 61496	4
Marking	CE
Width of protected area	0.2 ... 15 m
Protection field height	1800 mm
Number of beams	48
Operating mode	in the master
Optical resolution	60 mm
Angle of divergence	< 5 °

**Functional safety related parameters**

Safety Integrity Level (SIL)	SIL 3
Performance level (PL)	PL e
Category	Cat. 4
Mission Time (T <sub>M</sub> )	20 a
PFH <sub>d</sub>	1.35 E-8
Type	4

**Indicators/operating means**

Operating display	in the master
Diagnostics display	in the master
Function display	in the master
Pre-fault indication	in the master
Controls	in the master

**Electrical specifications**

Operating voltage	U <sub>B</sub>	from master
No-load supply current	I <sub>0</sub>	from master
Protection class		III

**Input**

Test input	in the master
Function input	in the master

**Output**

Safety output	in the master
Signal output	in the master
Response time	depends on height of protective field

**Ambient conditions**

Ambient temperature	0 ... 55 °C (32 ... 131 °F)
Storage temperature	-25 ... 70 °C (-13 ... 158 °F)
Relative humidity	max. 95 %, not condensing

**Mechanical specifications**

Housing length L	1910 mm
Protection degree	IP67
Connection	M20 cable gland , terminal compartment with screw terminals, lead cross-section max. 1.5 mm <sup>2</sup>
Material	
Housing	extruded aluminum profile, RAL 1021 (yellow) coated
Optical face	Plastic pane
Mass	Per 5700 g

**General information**

System components	
Emitter	SLC60-1800-T-S
Receiver	SLC60-1800-R-S

**Compliance with standards and directives**

Directive conformity	
Machinery Directive 2006/42/EC	EN ISO 13849-1:2008 EN 61496-1:2004/A1:2008
EMC Directive 2004/108/EC	EN 61000-6-4:2007 + A1:2011
Standard conformity	
Standards	IEC 61496-2:2006 EN 50178:1997

**Approvals and certificates**

CE conformity	CE
UL approval	cULus Listed
CCC approval	Products with a maximum operating voltage of ≤36 V do not bear a CCC marking because they do not require approval.
TÜV approval	TÜV

Curves/Diagrams



Release date: 2012-08-01 12:24 Date of issue: 2012-08-01 117614\_eng.xml

**Notes**

**Response times of cascading units**

If cascading units are set up, the response time of the entire SLC, consisting of a master and a slave, must be determined. The overall number of beams for master and slave can be determined from technical data sheets. Depending on the type of output, the resulting response time can be read from the table.

Number of beams	Response time in milliseconds	
	Semiconductor output	Relay output
8	10	30
16	10	30
24	12	32
32	14	34
40	16	36
48	18	38
56	20	40
64	22	42
72	24	44
80	26	46
88	28	48
96	30	50

**Example:** Master: SLC14-300/31 32 beams  
Slave: SLC60-90-S+ 24 beams  
56 beams

56 beams, OSSD relay --> response time = 40 ms.

## Notes

### Master slave mode

Master: SLC... (semiconductor)  
or  
SLC.../31 (relay)  
Slave: SLC...-S

Using slaves makes it possible to lengthen protective fields or to form protective fields that lie in more than just one level. When you select slaves that can be connected, you should take into consideration that the maximum number of 96 light rays must not be exceeded.

There are slaves for transmitters and receivers. These may simply be connected to the master light curtain. As many as 2 slaves may be connected respectively to the transmitter and receiver unit.

### Installation:

- 1 The end cap should be screwed off for the light curtain (without cable gland).
- 2 The plug-in jumper on the connectors of the printed circuit board, which is now visible, should be removed.
- 3 The slave is designed so that the cap located on the cable connector can be plugged directly onto the open end of the light curtain with the printed circuit board.
- 4 After you have screwed on the connection cap, the system is complete.

## System accessories

- Mounting set SLC
- Test rods SLC14/SLC30/SLC60
- Protective glass pieces for SLC (to protect the optically functional surface)
- Lateral screwed connection SLC
- Profile alignment aid
- Laser alignment aid SLC
- Mirror for SLC (for securing hazardous areas on multiple sides)
- Ground pillar UC SLP/SLC
- Housing for pillar  
Enclosure UC SLP/SLC
- Collision protector  
Damping UC SLP/SLC