

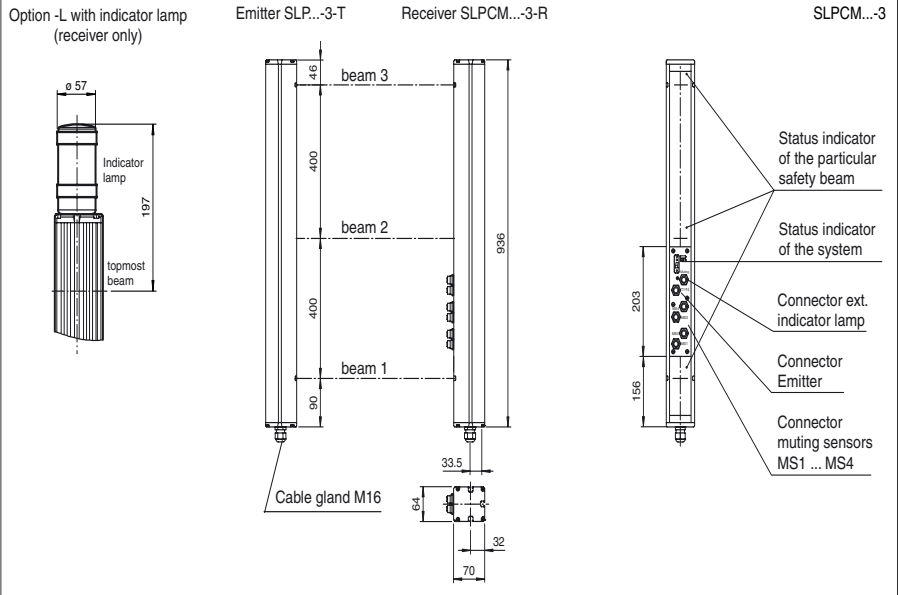

Dimensions



Model Number

SLPCM65-3-L

Safety light grid with integrated control unit
with 2 separate fail-safe semiconductor outputs

Features

- Detection range up to 65 m
- 3-Radial design
- Beam spacing 400 mm
- Self-monitoring (type 4 according to IEC/EN 61496-1)
- Red transmission light
- Usable with or without start/restart disable
- Sequential and parallel muting in various operating modes
- Emergency muting for the correction of the material jam
- Integrated relay monitor
- 7-segment diagnostic display
- Integrated function display
- Pre-fault indication
- OSSD outputs as semiconductor or relay outputs

Accessories

PG SLP-3
Mounting aid Safety

Electrical connection

Emitter SLP

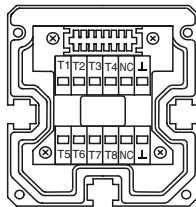

- T1 - Emitter channel 1
- T2 - Emitter channel 2
- T3 - Emitter channel 3
- L - 0 V

Receiver SLPCM

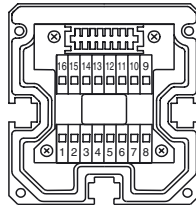

Receiver SLPCM (semiconductor outputs)	Receiver SLPCM/31 (Relay outputs)
4 - n.c.	1 - Functional earth
5 - -	2 - 0 V
6 - +	3 - 24 V
7 - OSSD 1	4 - [Relay symbol]
8 - OSSD 2	5 - [Relay symbol]
	6 - [Relay symbol]
	7 - [Relay symbol]
	8 - [Relay symbol]
	9 - Input, Relay monitor
	10 - Input, Start release
	11 - Input, Reset
	12 - PNP-output, Soiled optics
	13 - PNP-output, Muting lamp
	14 - PNP-output, Startup readiness
	15 - PNP-output, Indicator OSSD OFF
	16 - PNP-output, Indicator OSSD ON

Release date: 2009-12-14 11:23 Date of issue: 2009-12-14 11:4900_ENG.xml

Technical data**General specifications**

Effective detection range	12 ... 65 m
Light source	LED
Light type	red, modulated light
Approvals	TÜV
Tests	IEC/EN 61496
Safety type according to IEC/EN 61496	4
Marking	CE
Obstacle size	static: 32 mm dynamic: 50 mm (at v = 1.6 m/s of the obstacle)
Beam spacing	400 mm
Number of beams	3
Operating mode	Start/restart disable, relay monitor, muting operating modes
Angle of divergence	< 5 °

Functional safety related parameters

Safety Integrity Level (SIL)	SIL 3
Performance level (PL)	PL e
Category	Cat. 4
Mission Time (T _M)	20 a
PFH _d	3.54 E-9

Indicators/operating means

Diagnosis display	7-segment display
Function display	LED red: per receiver channel off: interruption flashes: receiver continuously on: reception with sufficient stability control on the front plate: LED red: OSSD off LED green: OSSD on LED yellow: types of muting operation
Muting display	Indicator lamp
Pre-fault indication	LED red next to receiver flashes
Operating elements	10 DIP switch in receiver terminal compartment

Electrical specifications

Operating voltage	U _B	24 V DC -15 % / +25 % , electrically isolated
No-load supply current	I ₀	max. 250 mA
Protection class		III

Input

Activation current	approx. 10 mA
Activation time	0.03 ... 1 s
Test input	Reset-input for system test
Function input	Relay monitor, start release, muting sensors (max. 4)

Output

Output of the pre-fault indication	1 PNP, +U _B -2 V, max. 300 mA
Safety output	2 separated fail safe semiconductor outputs
Signal output	1 PNP each, max. 300 mA for startup readiness, OSSD on, OSSD off, muting lamp, signals in parallel in the lamp socket
Switching voltage	Operating voltage -2 V
Switching current	max. 0.5 A
Response time	20 ms

Ambient conditions

Ambient temperature	0 ... 50 °C (273 ... 323 K)
Storage temperature	-20 ... 70 °C (253 ... 343 K)
Relative humidity	max. 95 %, not condensing

Mechanical specifications

Protection degree	IP65
Connection	Cable screwed connection M16 , terminal compartment with cage terminals, M12 connector for transmitters, muting lamp, etc., muting sensors, lamp socket for muting lamp, etc.
Connection options	Further electrical connection options on request: Connector DIN 43 651 Hirschmann, emitter: 6-pin+PE, receiver: 11-pin+PE
Material	
Housing	aluminium extruded structural profile, RAL 1021 (yellow) coated
Optical face	Plastic pane
Mass	Per 3400 g

General information

System components	
Emitter	SLP65-3-T
Receiver	SLPCM65-3-R-L

Curves/Diagrams

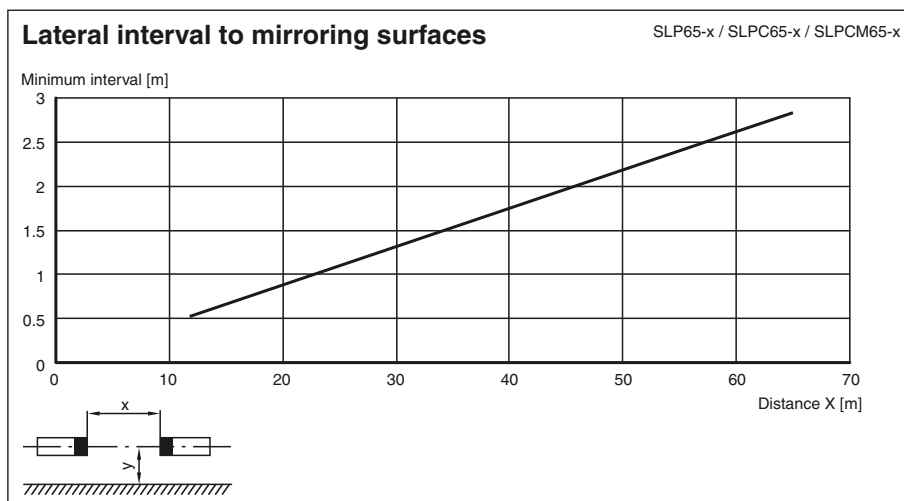
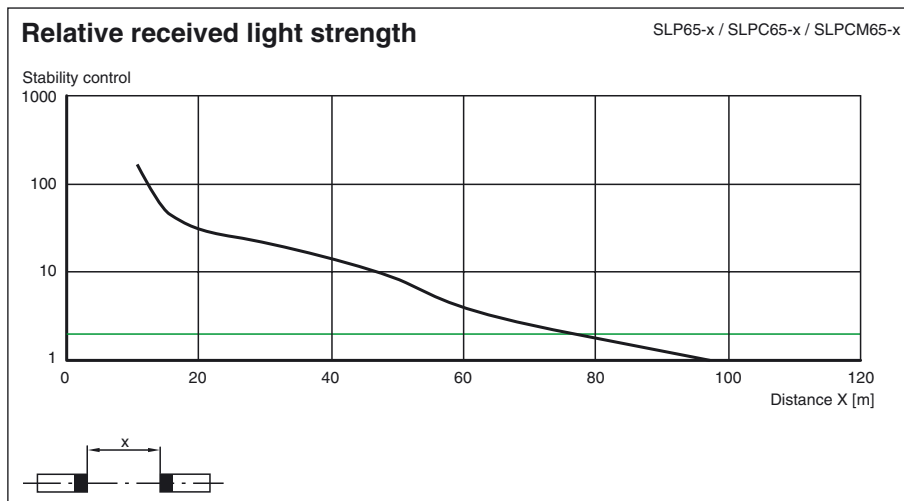
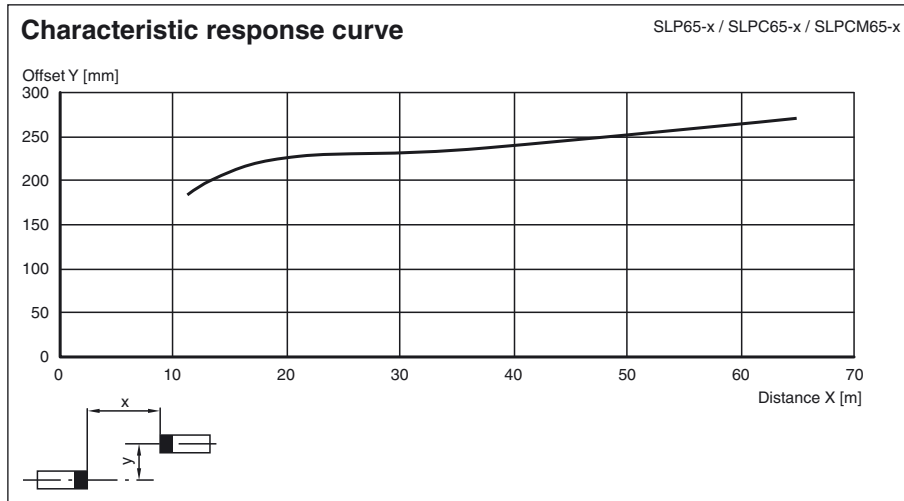

Release date: 2009-12-14 11:23 Date of issue: 2009-12-14 11:4900_ENG.xml

Additional information

Socket assignment on the front side of the device

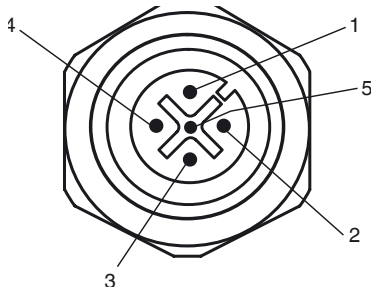

Indicator lamp control 

Socket	Function
1	OSSD on
2	OSSD off
3	0 V
4	Readiness for startup
5	Muting (monitored)

T1 - T4 transmitter control

Socket	Function
1	Transmitter channel 1
2	Transmitter channel 2
3	0 V
4	Transmitter channel 3

Muting sensor inputs MS1 - MS4

Socket	Function
1	+ 24 V
3	0 V
4	Sensor signal

System accessories

- Mounting set MS SLP
- Profile alignment aid PA SLP/SLC
- Laser alignment aid BA SLP
- Ground pillar UC SLP/SLC
- Housing for pillar Enclosure UC SLP/SLC
- Collision protector Damping UC SLP/SLC
- Redirection mirror SLP-3-M

Release date: 2009-12-14 11:23 Date of issue: 2009-12-14 114900_ENG.xml