

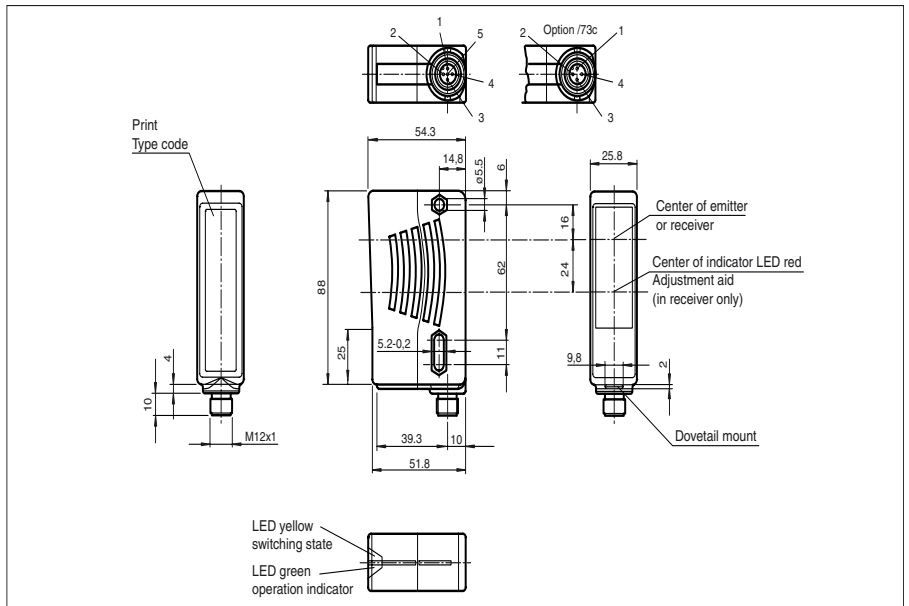

Dimensions



Model Number

SLA28/35/105/106 R=65m

Safety thru-beam sensor
with 5-pin, M12 x 1 plastic connector

Features

- Detection range up to 65 m
- Self-monitoring (type 4 according to IEC/EN 61496-1)
- Red transmission light
- Integrated alignment aid
- Clearly visible LED functional display and pre-fault indicator on the receiver
- Extended temperature range up to -35 °C with heated front panel
- Sturdy housing
- Waterproof, protection class IP67
- Operation on control units of SB4 (SafeBox)

Accessories

OMH-21
Mounting aid

Electrical connection

Design with connector plug

Receiver:

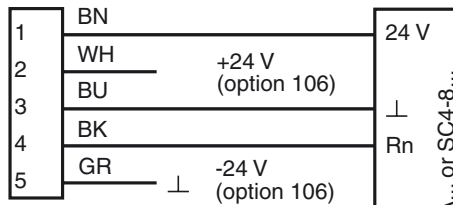

Emitter:

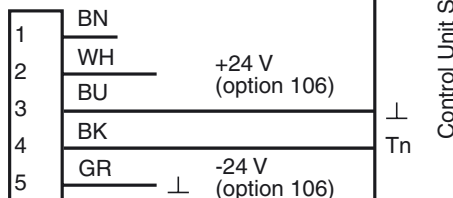

Pinout

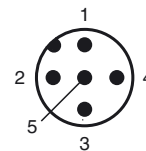

Release date: 2009-12-14 11:09 Date of issue: 2009-12-14 11:2355_ENG.xml

Additional accessories can be found in the Internet.

Subject to modifications without notice

Pepperl+Fuchs Group
www.pepperl-fuchs.com

USA: +1 330 486 0001
fa-info@us.pepperl-fuchs.com

Germany: +49 621 776-4411
fa-info@pepperl-fuchs.com

Copyright Pepperl+Fuchs

Singapore: +65 6779 9091
fa-info@sg.pepperl-fuchs.com

Technical data

General specifications

Effective detection range	6 ... 65 m
Number of protective field beams	1
Light source	LED
Light type	red, modulated light
Approvals	TÜV
Tests	IEC/EN 61496
Safety type according to IEC/EN 61496	4
Marking	CE, cULus
Obstacle size	static: 30 mm dynamic: 40 mm (at v = 1.6 m/s of the obstacle)
Alignment aid	LED red in receiver
Angle of divergence	< 5 °

Functional safety related parameters

Safety Integrity Level (SIL)	SIL 3
Performance level (PL)	PL e
Category	Cat. 4
Mission Time (T _M)	20 a
PFH _d	4.4 E-10

Indicators/operating means

Function display	LED yellow/green in receiver: off: Interruption yellow: transmission green: reception with sufficient stability control
Pre-fault indication	LED functional display yellow

Electrical specifications

Operating voltage	U _B	Power supply via control unit
-------------------	----------------	-------------------------------

Ambient conditions

Ambient temperature	-40 ... 60 °C (233 ... 333 K) with heated optical face, fixed voltage 24 V DC ± 20 %/50 mA	
Storage temperature	-20 ... 70 °C (253 ... 343 K)	
Relative humidity	max. 95 %, not condensing	

Mechanical specifications

Protection degree	IP67
Connection	M12 connector, 5 pin
Material	
Housing	ABS plastic, RLA 1021 (yellow) painted
Optical face	Plastic pane
Mass	Per 70 g

General information

System components	
Emitter	SLA28-T/35/105/106 R=65m
Receiver	SLA28-R/35/105/106 R=65m

Curves/Diagrams

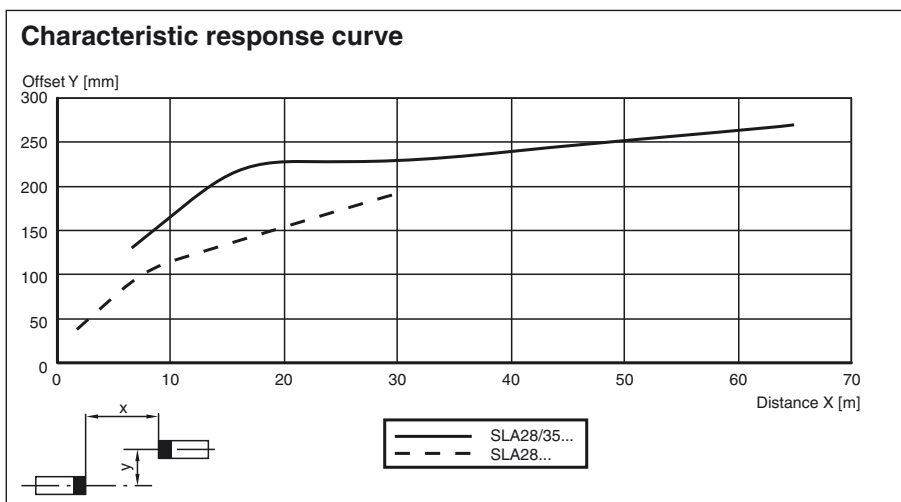

Release date: 2009-12-14 11:09 Date of issue: 2009-12-14 11:255_ENG.xml

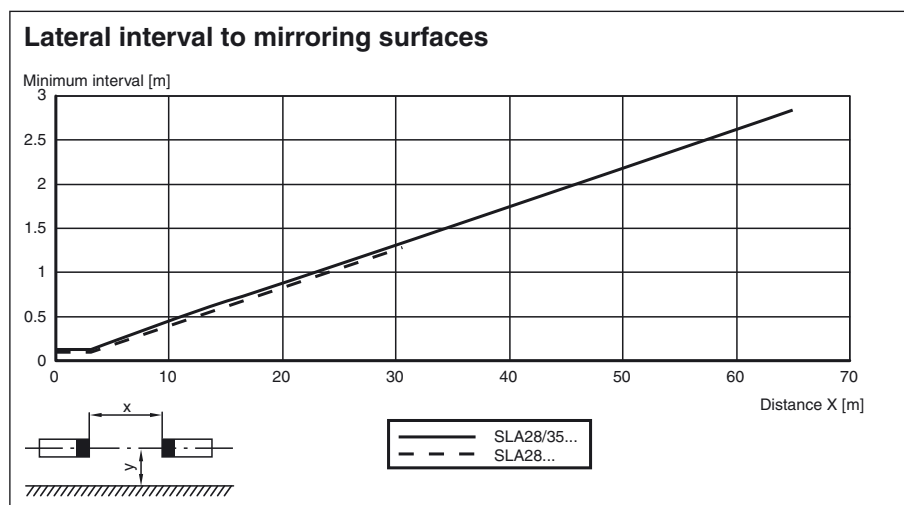
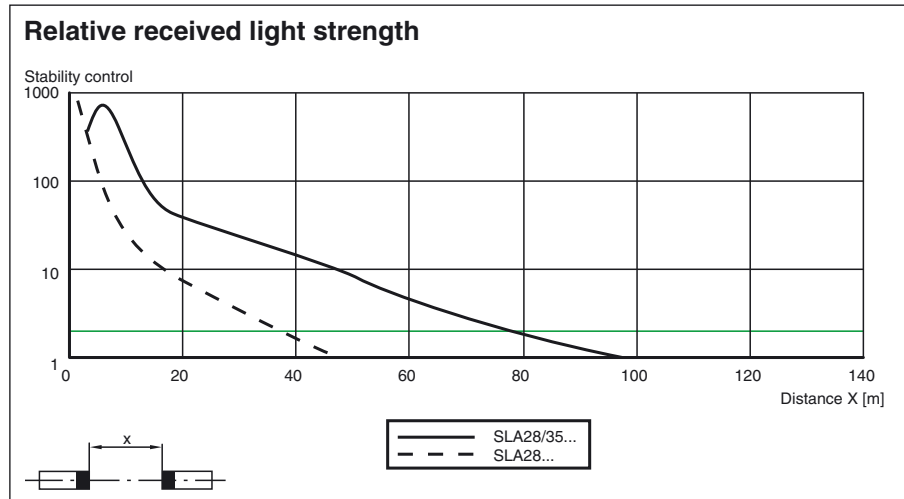

Additional information

For much easier alignment even for long distance applications, an additional red LED is located in the receivers optics:

- LED constantly illuminated:
signal strength < switching level
- LED flashes:
signal strength is between 1-fold switching level and 2-fold switching level
- LED off:
signal strength \geq 2-fold switching level (function reserve)

System accessories

Control units

SLVA4-K plus
SLVA8-K
SC4-8

Cable sockets

Option /105:

straight: V15-G-2M-PVC
V15-G-5M-PVC
V15-G-10M-PVC
angled: V15-W-2M-PVC
V15-W-5M-PVC
V15-W-10M-PVC

Release date: 2009-12-14 11:09 Date of issue: 2009-12-14 11:2355_ENG.xml

Option /116: no

Mounting aids

OMH-21
OMH-22
OMH-05
OMH-MLV11-K

Further accessories

Laser alignment aid
BA SLA28

Muting Set
MS SLP/SLA28

Redirection mirror
SLA-1-M