

Dimensions

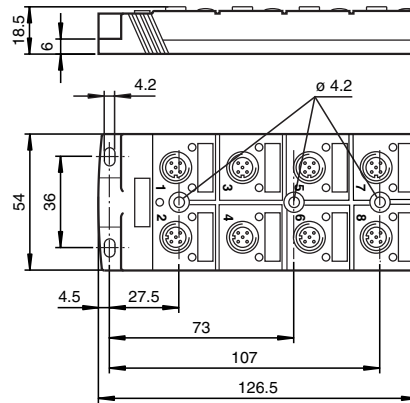

Model number

SACB-8/8-L-5,0PUR

Octuple splitter boxes with M12 connector with basic cable

Features

- Flat housing
- LED indicator for module supply and I/O status
- Protection degree IP67

Accessories

MH 05-SACB-8

Mounting aid

VAZ-V1-B

Blind plug

Technical data

General specifications

Number of poles 4

Indicators/operating means

LED green supply voltage each module  
LED yellow I/O status indication

Electrical specifications

Operating voltage 24 V DC, max. 30 V DC  
Operating current ≤ 5 mA per channel indication element  
Current loading capacity ≤ 2 A per channel, ≤ 4 A per plug-in station, ≤ 12 A total current per separator

Ambient conditions

Ambient temperature -25 ... 75 °C (248 ... 348 K)  
movable cable: -5 ... 70 °C (268 ... 343 K),  
fixed cable: -30 ... 90 °C (243 ... 363 K)

Mechanical specifications

Protection degree IP67 according to EN 60529  
Connection Cable: flexible lead  
Sockets M12 , 4-pin  
Cable flexible  
Sheath diameter 9.2 mm  
Bend radius > 10 x conductor diameter, appropriate for conveyor chains  
Cores Signalling line (4): 8 x 0.34 mm<sup>2</sup>  
Supply line (1, 3), PE (5): 3 x 0.75 mm<sup>2</sup>  
Length L 5 m  
Mass approx. 630 g

Electrical connection

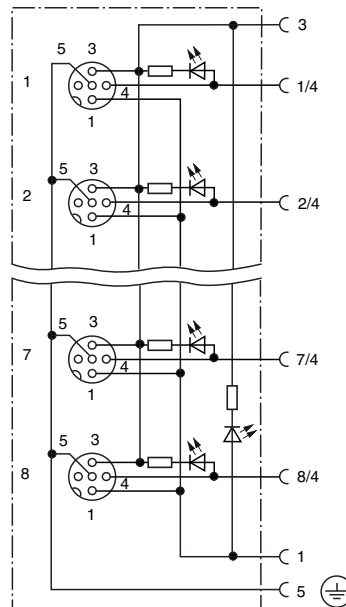

Core colour	M12-socket/pole
WH	1/4 (A)
GN	2/4 (A)
YE	3/4 (A)
GY	4/4 (A)
PK	5/4 (A)
RD	6/4 (A)
BK	7/4 (A)
VT	8/4 (A)
BN	1 ... 8/1 (+24 V)
BU	1 ... 8/3 (0 V)
GN/YE	1 ... 8/5 (PE)

Display

