



Model Number

NJ40+U4+W-BHMS3-N.O.

Features

- 2-wire AC
- Surface mount
- Sensing range 40 mm

Connection

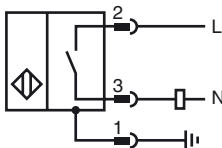

Pinout

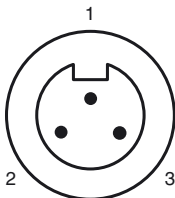

Wire colors

1	GN	(green)
2	BK	(black)
3	WH	(white)

Dimensions

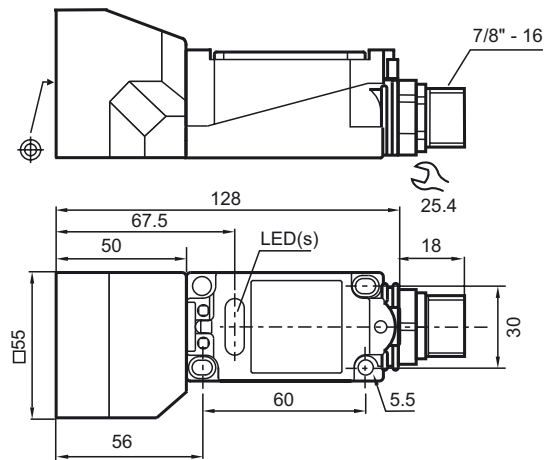

Technical Data

General specifications

Switching element function	AC	NO
Rated operating distance	s_n	40 mm
Installation	non-flush	
Output polarity	AC	
Assured operating distance	s_a	0 ... 32.4 mm
Reduction factor r_{Al}	0.5	
Reduction factor r_{Cu}	0.45	
Reduction factor r_{304}	0.8	

Nominal ratings

Operating voltage	U_B	20 ... 253 V ¹⁾
Switching frequency	f	0 ... 20 Hz
Hysteresis	H	1 ... 10 typ. 5 %
Voltage drop	U_d	≤ 5 V
Momentary current (20 ms, 0.1 Hz)	0 ... 3000 mA	
Operating current	I_L	8 ... 500 mA
Off-state current	I_r	0.5 ... 1.95 mA typ. 1.2 mA
Operating voltage display	LED, green	
Indication of the switching state	LED, yellow	

Functional safety related parameters

MTTF _d	760 a
Mission Time (T _M)	20 a
Diagnostic Coverage (DC)	0 %

Ambient conditions

Ambient temperature	-25 ... 70 °C (-13 ... 158 °F)
Storage temperature	-25 ... 85 °C (-13 ... 185 °F)

Mechanical specifications

Connection type	Quick disconnect type BHMS3
Housing material	PBT
Sensing face	PBT
Housing base	metal
Protection degree	IP68
Note	¹⁾ In the temperature range below 0 °C, permissible operating voltage U_B 80...253 V

Compliance with standards and directives

Standard conformity	
Standards	EN 60947-5-2:2007 IEC 60947-5-2:2007

Approvals and certificates

UL approval	cULus Listed, General Purpose
CSA approval	cCSAus Listed, General Purpose
CCC approval	Certified by China Compulsory Certification (CCC)

Release date: 2012-05-29 11:30 Date of issue: 2012-05-29 088946_eng.xml