

OBT200L-18GM70-E4-V1

Fibre optics sensor

OBT200L-18GM70-E4-V1

with 4-pin, M12 connector

CE



- ◆ Sensing range up to 200 mm
- ◆ Light/dark ON, programmable
- ◆ Sensitivity adjuster for optimal adaptation to the application
- ◆ Strong metallic housing in cylindrical shape M18 x 1
- ◆ LED indicator for a simple operation start
- ◆ Protection degree IP67
- ◆ For glass fibre optics
- ◆ Sensing range depends on the fibre optics being used

Release date: 2004-07-20 09:39 Date of issue: 2005-07-06 083177_ENG.xml

General specifications

Detection range	depends on the fibre optics being used
Light source	LED
Approvals	CE
Adjustment range	20 ... 200 mm
Reference target	standard white 50 mm x 50 mm (in direct detection)
Light type	infrared, modulated light
Ambient light limit	10000 Lux

Indicators/operating means

Function display	LED yellow: switching state
------------------	-----------------------------

Electrical specifications

Operating voltage	10 ... 30 V DC
Ripple	10 %
No-load supply current I_0	≤ 20 mA
Time delay before availability t_v	≤ 50 ms

Output

Switching type	Light/dark ON, programmable
Signal output	1 switch output npn
Switching voltage	max. 30 V DC
Switching current	max. 100 mA
Voltage drop U_d	≤ 2.5 V
Switching frequency f	≤ 300 Hz
Switch-on delay t_{on}	1.5 ms
Response time	≤ 1.5 ms

Standard conformity

Standards	EN 60947-5-2
-----------	--------------

Ambient conditions

Ambient temperature	-25 ... 55 °C (248 ... 328 K)
Storage temperature	-40 ... 70 °C (233 ... 343 K)

Mechanical specifications

Protection degree	IP67
Connection	connector M12 x 1, 4-pin
Material	
Housing	brass, nickel-plated
Optical face	PMMA
Mass	45 g

Release date: 2004-07-20 09:39 Date of issue: 2005-07-06 083177_ENG.xml

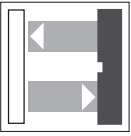

OBT200L-18GM70-E4-V1

Release date: 2004-07-20 09:39 Date of issue: 2005-07-06 08:177_ENG.xml

Dimensions

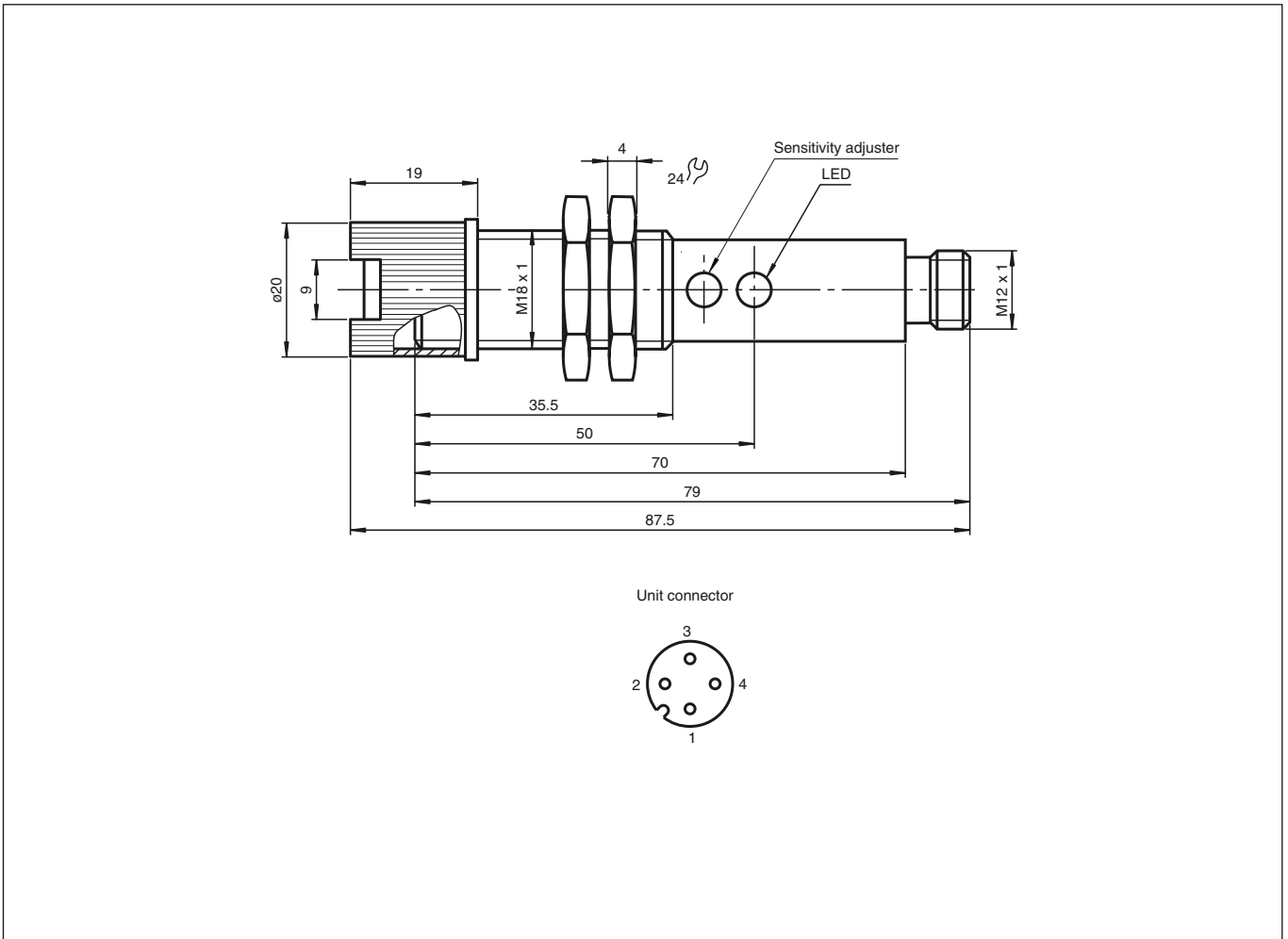

Electrical connection

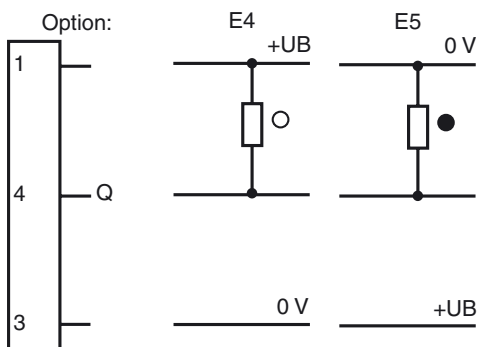

○ = light on, ● = dark on

Release date: 2004-07-20 09:39 Date of issue: 2005-07-06 083177_ENG.xml

Selection table for fibre

	Model number	Range in mm	Detection range in mm	Fig.
fibre optic, single path with PVC coating	LCE 18-2,3-0,5-K2	600		1
	LCE 18-2,3-0,5-K9	600		4
fibre optic, single path with metal coating	LME 18-1,9-0,5-K9	500		4
	LME 18-2,3-0,5-K10	600		5
	LME 18-2,3-0,5-K2	600		1
	LME 18-2,3-0,5-K3	600		2
	LME 18-2,3-0,5-K4	600		3
	LME 18-2,3-1,0-K2	600		1
	LME 18-2,3-2,0-K2	600		1
Glass fibre optics, single path with silicon coating	LSE 18-1,1-0,5-K9	100		4
fibre optic, reflex with PVC coating	LCR 18-2,7-1,0-K9		75	12
	LCR 18-3,2-0,5-K1		100	6
	LCR 18-3,2-0,5-K2		100	7
	LCR 18-3,2-2,0-K2		100	7
	LMR 18-1,1-0,5-K3		10	8
	LMR 18-2,3-0,25-K3		45	8
Glass fibre optics, reflex with metal coating	LMR 18-2,3-0,5-K2		45	7
	LMR 18-2,3-0,5-K3		45	8
	LMR 18-2,3-0,5-K7		45	11
	LMR 18-2,7-0,5-K9		75	12
	LMR 18-3,2-0,5-K1		100	6
	LMR 18-3,2-0,5-K5		100	10
	LMR 18-3,2-1,0-K1		100	6
	LMR 18-3,2-1,0-K5		100	10
	LMR 18-3,2-2,0-K1		100	6
	LMR 18-3,2-2,0-K4		100	9
LMR 18-3,2-3,0-K1		100	6	
fibre optic, reflex with silicon coating	LSR 18-2,3-0,5-K12		45	13
	LSR 18-3,2-0,5-K1		100	6

Other lengths and end pieces available on request

Fig. 1

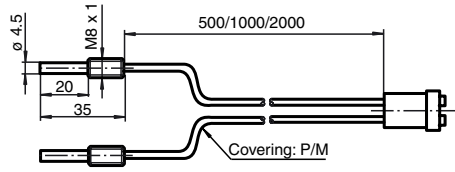

Fig. 2

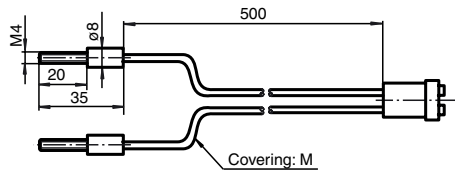

Fig. 3

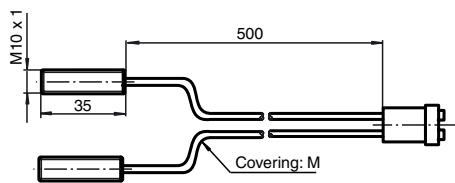

Fig. 4

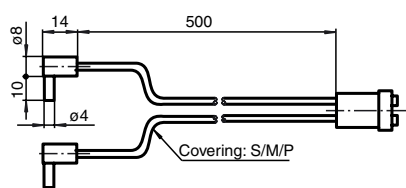

Fig. 5

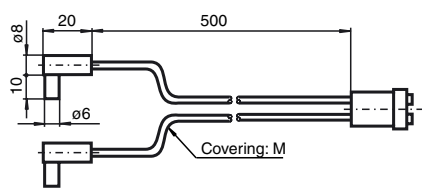

Fig. 6

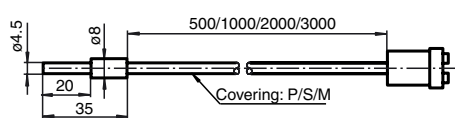

Fig. 7

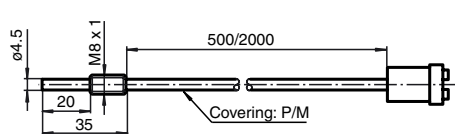

Fig. 8

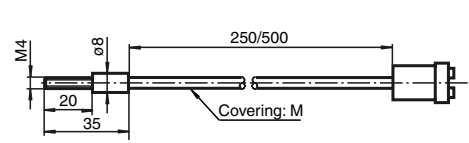

Fig. 9

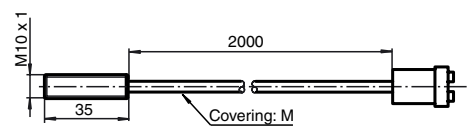

Fig. 10

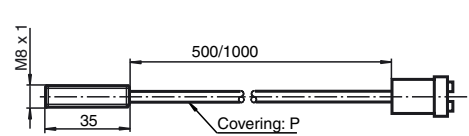

Fig. 11

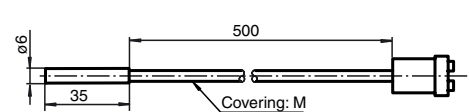

Fig. 12

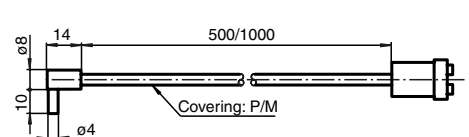
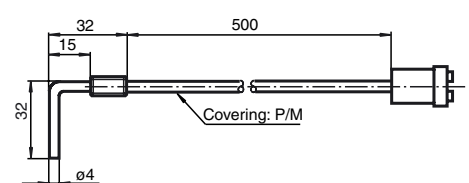

Fig. 13



Adapter

