



OBT200L-18GM70-E5

Fibre optics sensor

# OBT200L-18GM70-E5

with 2 m fixed cable

CE



- ◆ Sensing range up to 200 mm
- ◆ Light/dark ON, programmable
- ◆ Sensitivity adjuster for optimal adaptation to the application
- ◆ Strong metallic housing in cylindrical shape M18 x 1
- ◆ LED indicator for a simple operation start
- ◆ Protection degree IP67
- ◆ For glass fibre optics
- ◆ Sensing range depends on the fibre optics being used

Release date: 2004-07-20 09:39 Date of issue: 2005-07-06 08:31:42\_ENG.xml

**General specifications**

|                     |  |
|---------------------|--|
| Detection range     | depends on the fibre optics being used             |
| Light source        | LED  |
| Approvals           | CE   |
| Adjustment range    | 20 ... 200 mm                                      |
| Reference target    | standard white 50 mm x 50 mm (in direct detection) |
| Light type          | infrared, modulated light                          |
| Ambient light limit | 10000 Lux  |

**Indicators/operating means**

|                    |                             |
|--------------------|-----------------------------|
| Function display   | LED yellow: switching state |
| Operating elements | sensitivity adjuster        |

**Electrical specifications**

|                                      |                |
|--------------------------------------|----------------|
| Operating voltage                    | 10 ... 30 V DC |
| Ripple                               | 10 %           |
| No-load supply current $I_0$         | $\leq 20$ mA   |
| Time delay before availability $t_v$ | $\leq 50$ ms   |

**Output**

|                          |                             |
|--------------------------|-----------------------------|
| Switching type           | Light/dark ON, programmable |
| Signal output            | 1 switch output pnp         |
| Switching voltage        | max. 30 V DC                |
| Switching current        | max. 100 mA                 |
| Voltage drop $U_d$       | $\leq 2.5$ V                |
| Switching frequency $f$  | $\leq 300$ Hz               |
| Switch-on delay $t_{on}$ | 1.5 ms                      |
| Response time            | $\leq 1.5$ ms               |

**Standard conformity**

|           |              |
|-----------|--------------|
| Standards | EN 60947-5-2 |
|-----------|--------------|

**Ambient conditions**

|                     |                               |
|---------------------|-------------------------------|
| Ambient temperature | -25 ... 55 °C (248 ... 328 K) |
| Storage temperature | -40 ... 70 °C (233 ... 343 K) |

**Mechanical specifications**

|                   |   |
|-------------------|---|
| Protection degree | IP67                                      |
| Connection        | 2 m cable, 3 x 0,34 mm <sup>2</sup> , PVC |
| Material          |   |
| Housing           | brass, nickel-plated                      |
| Optical face      | PMMA                                      |
| Mass              | 45 g                                      |

Release date: 2004-07-20 09:39 Date of issue: 2005-07-06 083142\_ENG.xml



## OBT200L-18GM70-E5

Dimensions

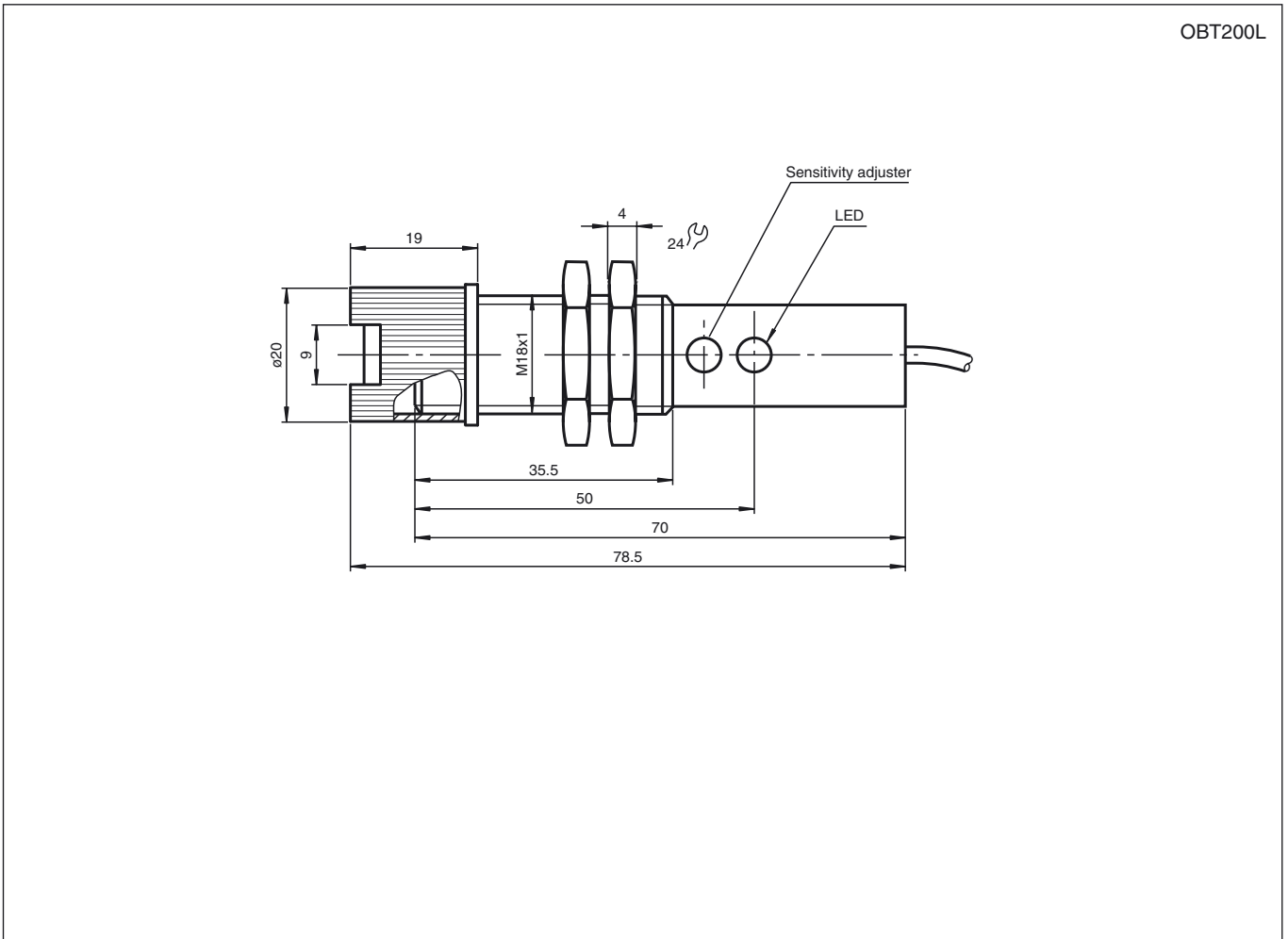

Electrical connection

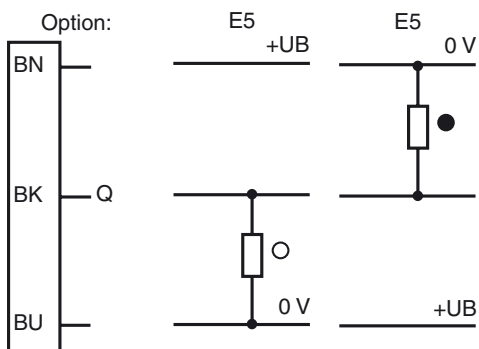

○ = light on, ● = dark on

**Selection table for fibre**

|  | Model number       | Range in mm | Detection range in mm | Fig. |
|--|--------------------|-------------|-----------------------|------|
| fibre optic,<br>single path with<br>PVC coating            | LCE 18-2,3-0,5-K2  | 600         |                       | 1    |
|  | LCE 18-2,3-0,5-K9  | 600         |                       | 4    |
| fibre optic,<br>single path with<br>metal coating          | LME 18-1,9-0,5-K9  | 500         |                       | 4    |
|  | LME 18-2,3-0,5-K10 | 600         |                       | 5    |
|  | LME 18-2,3-0,5-K2  | 600         |                       | 1    |
|  | LME 18-2,3-0,5-K3  | 600         |                       | 2    |
|  | LME 18-2,3-0,5-K4  | 600         |                       | 3    |
|  | LME 18-2,3-1,0-K2  | 600         |                       | 1    |
|  | LME 18-2,3-2,0-K2  | 600         |                       | 1    |
| Glass fibre optics,<br>single path with silicon<br>coating | LSE 18-1,1-0,5-K9  | 100         |                       | 4    |
| fibre optic,<br>reflex with<br>PVC coating                 | LCR 18-2,7-1,0-K9  |             | 75                    | 12   |
|  | LCR 18-3,2-0,5-K1  |             | 100                   | 6    |
|  | LCR 18-3,2-0,5-K2  |             | 100                   | 7    |
|  | LCR 18-3,2-2,0-K2  |             | 100                   | 7    |
|  | LMR 18-1,1-0,5-K3  |             | 10                    | 8    |
|  | LMR 18-2,3-0,25-K3 |             | 45                    | 8    |
| Glass fibre optics, reflex<br>with metal coating           | LMR 18-2,3-0,5-K2  |             | 45                    | 7    |
|  | LMR 18-2,3-0,5-K3  |             | 45                    | 8    |
|  | LMR 18-2,3-0,5-K7  |             | 45                    | 11   |
|  | LMR 18-2,7-0,5-K9  |             | 75                    | 12   |
|  | LMR 18-3,2-0,5-K1  |             | 100                   | 6    |
|  | LMR 18-3,2-0,5-K5  |             | 100                   | 10   |
|  | LMR 18-3,2-1,0-K1  |             | 100                   | 6    |
|  | LMR 18-3,2-1,0-K5  |             | 100                   | 10   |
|  | LMR 18-3,2-2,0-K1  |             | 100                   | 6    |
|  | LMR 18-3,2-2,0-K4  |             | 100                   | 9    |
| LMR 18-3,2-3,0-K1  |                    | 100         | 6                     |      |
| fibre optic,<br>reflex with<br>silicon coating             | LSR 18-2,3-0,5-K12 |             | 45                    | 13   |
|  | LSR 18-3,2-0,5-K1  |             | 100                   | 6    |

Other lengths and end pieces available on request

Fig. 1

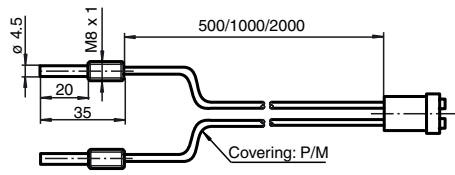

Fig. 2

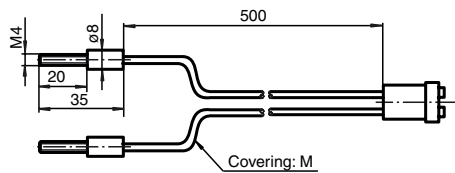

Fig. 3

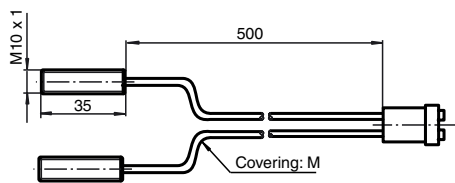

Fig. 4

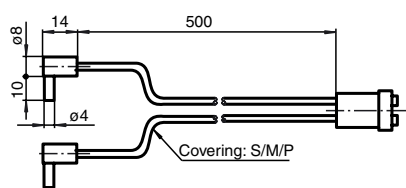

Fig. 5

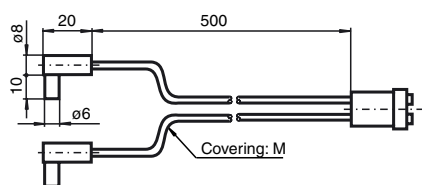

Fig. 6

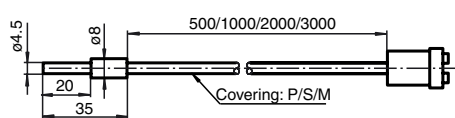

Fig. 7

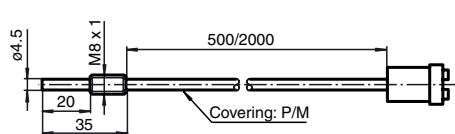

Fig. 8

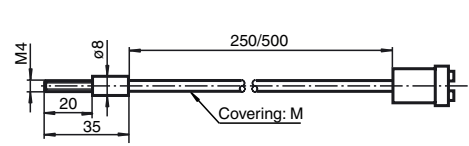

Fig. 9

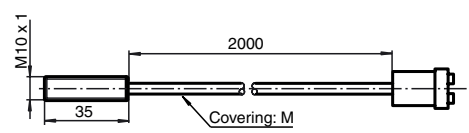

Fig. 10

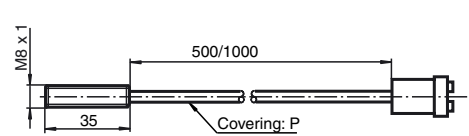

Fig. 11

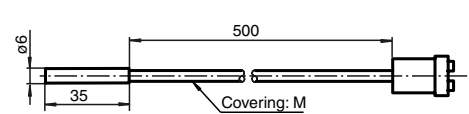

Fig. 12

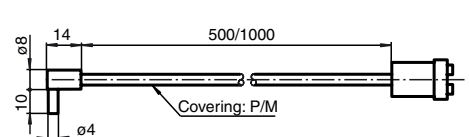
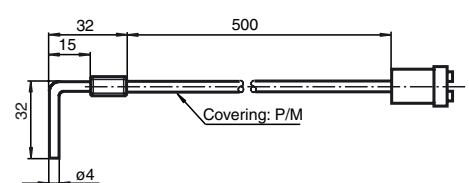

Fig. 13



Adapter

