

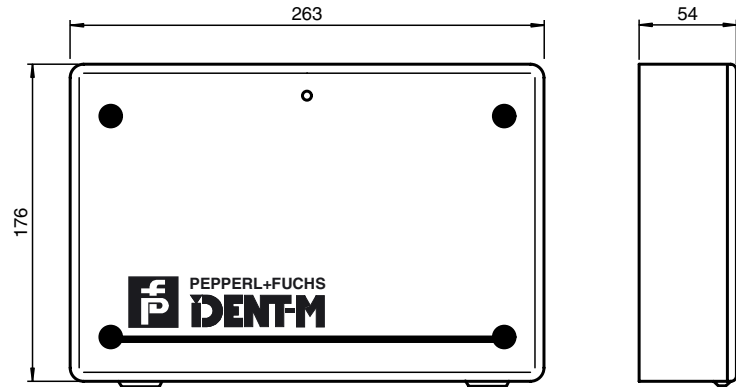

Dimensions



Model number

MTT-S3

Features

- Serial interfaces RS 232 and RS 485
- Dual-LED for function display
- Stand-alone functionality
- Inputs and outputs
- Motion recognition possible
- Multi-day capability
- 100 frequency channels
- Internal control unit with push button switches, 7-segment displays and buzzer

Technical data

General specifications

Operating frequency	2.435 ... 2.465 GHz , 100 ID-channels channel separation 300 kHz
Transfer rate	read: 4 kBit/s , 16 kBit/s write: 4 kBit/s
Operating distance	maximum: 4 m

Memory

Type/Size	flash EEPROM 3 x 128 kByte SRAM 128 kByte
-----------	--

Electrical specifications

Rated operational voltage	U_e	20 ... 28 V DC selectable via Jumper 10 ... 14 V DC
Current consumption		at 24 V: 150 mA at 12 V: 500 mA

Interface 1

Physical	RS 232
Protocol	ASCII

Interface 2

Protocol	ASCII
----------	-------

Ambient conditions

Ambient temperature	-20 ... 60 °C (253 ... 333 K)
Storage temperature	-20 ... 60 °C (253 ... 333 K)

Mechanical specifications

Protection degree	IP43 according to EN 60529
Material	front: polycarbonate back face: high grade steel
Mass	1.9 kg
Dimensions	263 mm x 176 mm x 54 mm (W x H x D)

Compliance with standards and directives

Directive conformity	
R&TTE Directive 1995/5/EC	EN 60950, IEC 60215, ETS 300683, ETS 300440

Electrical connection

Interface Description:

DTMF, LED, external control input

- J1: 1 LED 1
- 2 LED 2
- 3 GndLED
- 4 SDTMF
- 5 RtnDTMF
- 6 Tamp a
- 7 Tamp b

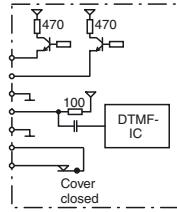

RS 232 for data station

- J2: 1 Tx 232a
- 2 Rx 232a
- 3 Gnd 232a

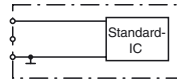

RS 232 / RS 485 for host processor

- J3: 1 Tx 232b
- 2 Rx 232b
- 3 Gnd 232b
- 4 CGnd
- 5 Tx-/Rx-485
- 6 Tx+/Rx+485
- 7 Gnd 485t
- 8 Rx 485-
- 9 Rx485+
- 10 Gnd 485r

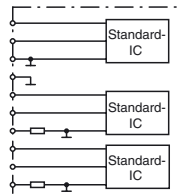

Parallel output and relays

- J4: 1 Outspl 1
- 2 Out 1c
- 3 Out 1e
- 4 Out 2c
- 5 Out 2e
- 6 R1c
- 7 R1b
- 8 R1m

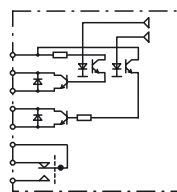

Parallel input

- J5: 1 In 1a
- 2 In 1c
- 3 In 2a
- 4 In 2c
- 5 In 3a
- 6 In 3c

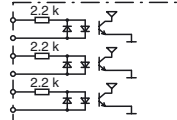

DC supply

- J6: 1 Spl 1
- 3 Spl 2
- 2 Rtnspl 1
- 4 Rtnspl 2

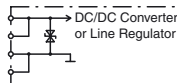

Function

The read/write device establishes the connection between the code and/or data carriers of the IDENT-M System T and a higher-order computer (industrial-PC, PLC, etc.). Communication with the computer occurs via an RS 232 or RS 485 (2- or 4-wire) serial interface.

The system is multi-tag capable, i.e. multiple code or data carriers are identified in the acquisition range. The read/write devices can be set to 100 different frequency channels, thereby preventing mutual interference.

The devices can also be used in stand-alone operation through various inputs and outputs.

An LED as well as a buzzer integrated in the device indicate the operating status.

The device can be adjusted and tested via an internal control panel with two push button switches and two 7-segment displays. It is also possible to perform the parameterisation via a so-called setup tag.

The device is delivered ex works with the "P+F-Talk" protocol software. Defined in this Pepperl+Fuchs protocol are a wide range of commands which allow the user to perform simple communication operations between the higher-order computer and the read/write device.

Additional information can be found in the descriptions of the system and device.

Software

Communication with the identification system is very easy with the demo program IDENT 2005. It shows the system options and simplifies commissioning. The demo program is included in the scope of delivery.

Notes

MTT Internal View

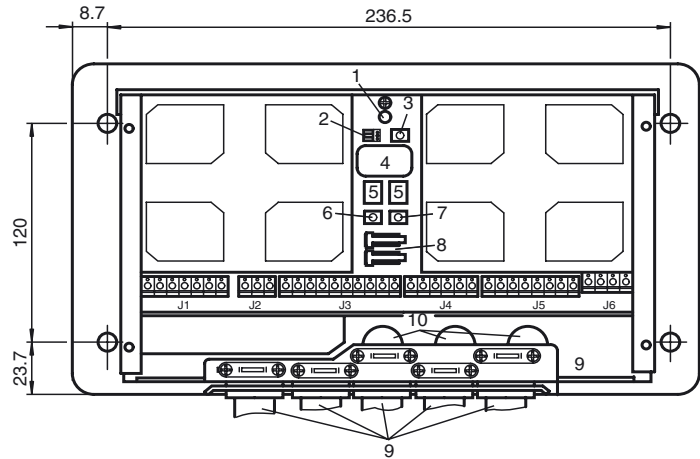
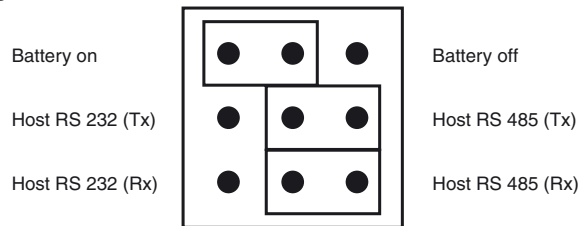

Illustration of MTT-S1 Hardware Features:

- | | |
|---------------------|-----------------------------------|
| 1 Multicoloured LED | 6 "Parameter-selection" button |
| 2 Jumper field | 7 "Value-selection" button |
| 3 RESET-button | 8 Monitor contact for the cover |
| 4 Buzzer | 9 Cable connection access, bottom |
| 5 Display | 10 Cable connection access, back |

Jumper settings



Microwave field shape

- HS Reading speed (16 kBit/s)
- LS Reading speed (4 kBit/s)
- W(m) Wave width
- Pr Transfer range (70 % of R_{max})
- Pp Data transfer range (70 % of R_{max})
- R (m) Range

