



Model Number

NJ20+U3+E2

Features

- Comfort series
- 20 mm embeddable

Connection

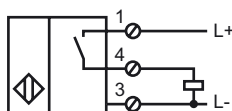

Dimensions

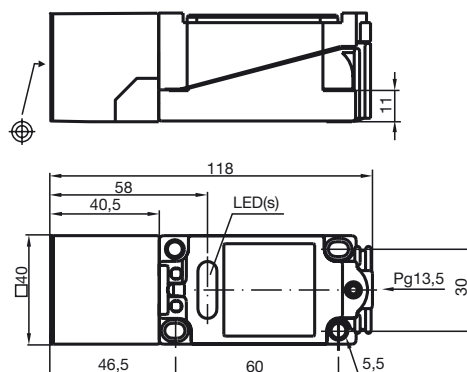

Technical Data

General specifications

Switching element function		PNP	NO
Rated operating distance	s_n	20 mm	
Installation		embeddable	
Output polarity		DC	
Assured operating distance	s_a	0 ... 16.2 mm	
Reduction factor r_{Al}		0.35	
Reduction factor r_{Cu}		0.35	
Reduction factor r_{303}		0.8	

Nominal ratings

Operating voltage	U_B	10 ... 60 V
Switching frequency	f	0 ... 150 Hz
Hysteresis	H	1 ... 10 typ. 5 %
Reverse polarity protected		reverse polarity protected
Short-circuit protection		pulsing
Voltage drop	U_d	≤ 2.8 V
Operating current	I_L	0 ... 200 mA
Off-state current	I_r	0 ... 0.5 mA typ. 0.01 mA
No-load supply current	I_0	≤ 10 mA
Operating voltage display		LED, green
Indication of the switching state		LED, yellow

Ambient conditions

Ambient temperature	-25 ... 70 °C (-13 ... 158 °F)
Storage temperature	-25 ... 85 °C (-13 ... 185 °F)

Mechanical specifications

Connection type	screw terminals
Core cross-section	up to 2.5 mm ²
Housing material	PBT/metal
Sensing face	PBT
Protection degree	IP68

Compliance with standards and directives

Standard conformity	
Standards	EN 60947-5-2:2007 IEC 60947-5-2:2007

Approvals and certificates

UL approval	cULus Listed, General Purpose
CSA approval	cCSAus Listed, General Purpose
CCC approval	Certified by China Compulsory Certification (CCC)