

- Single turn resolution ≤ 10 bit
- Robust design
- Shock and vibration protected



Technical data

Operating temperature	-40 °C .. +80 °C
Ingress protection class [IEC 60529]	IP67/IP66 (Encoder body/Shaft inlet)
Current consumption	40 mA at 24 Vdc
Vibration [IEC 60068-2-6]	≤ 300 m/s ²
Shock [IEC 60068-2-27]	≤ 2000 m/s ²
Cover material	Aluminium
Weight	300 g
Shaft load (axial/radial)	50 N / 60 N
Shaft material	Stainless steel
Rotational speed max	6000 rpm
Polarity protected	Yes

Encoder configuration

Type	RSA
Model	506 Singleturn
Shaft type	Ø6 mm with partial flat
Flange type	Synchro flange (63-type)
Resolution	10 bit singleturn
Power supply	9-36 Vdc
Output signal	Parallel Gray
Connection type	Cable
Connecting direction	Radial
Cable length	3.00 m

Dimensions

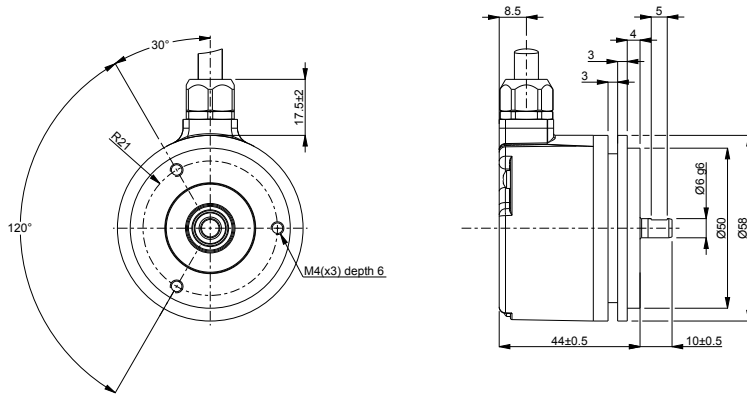

Output signals

Pin configuration

Function	Colour
+E Volt	Red
0 Volt	Blue
Bit 1	White
Bit 2	Brown
Bit 3	Green
Bit 4	Yellow
Bit 5	Grey
Bit 6	Pink
Bit 7	Black
Bit 8	Violet
Bit 9	Grey/Pink
Bit 10	Blue/Red
Code sequence	White/Yellow
/Hold	Brown/Yellow
Chassis	Shield

Ordering information

Part number

822509-03