

- 58mm diameter
- Extremely robust design
- Shock and vibration protected
- Inductive scanning



Technical data

Operating temperature	-40 °C .. +70 °C
Ingress protection class [IEC 60529]	IP67
Current consumption	100 mA at 24 Vdc
Vibration [IEC 60068-2-6]	≤ 300 m/s ²
Shock [IEC 60068-2-27]	≤ 2000 m/s ²
Cover material	Aluminium (anodized)
Weight	430 g
Shaft load (axial/radial)	100 / 125 N
Shaft material	Stainless steel
Rotational speed max	12000 rpm
Polarity protected	Yes

Encoder configuration

Type	ISA
Model	608 Multiturn
Shaft type	Ø6 mm round
Flange type	Clamping flange (61sp-type)
Resolution	25 bit (13 bit singleturn + 12 bit multiturn)
Power supply	9-36 Vdc
Output signal	PROFINET
Connection type	3xM12 connectors
Connecting direction	Radial

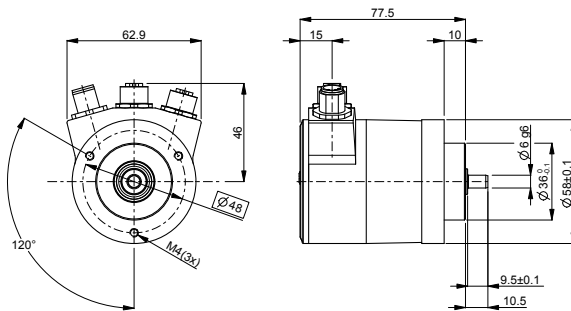
Dimensions**Output signals****Pin configuration**

Function	Pin
4p D-coded M12 (Port 2)	
Tx+	1
Rx+	2
Tx-	3
Rx-	4
4p D-coded M12 (Port 1)	
Tx+	1
Rx+	2
Tx-	3
RX-	4
4p A-coded M12 (Supply)	
+E Volt	1
0 Volt	3

Ordering information

Part number

812421-01