

- Performance hollow shaft encoder for heavy duty industries
- High vibration and shock resistance
- Electrically insulated shaft



## Technical data

Operating temperature	-20 °C .. +85 °C
Ingress protection class [IEC 60529]	IP67 (IP66 at shaft inlet)
Vibration [IEC 60068-2-6]	≤ 200 m/s <sup>2</sup>
Shock [IEC 60068-2-27]	≤ 1500 m/s <sup>2</sup>
Cover material	Aluminium (anodized)
Weight	1400 g
Shaft load (axial/radial)	100 N / 300 N
Rotational speed max	6000 rpm
Shaft material	Stainless steel with insulated peek insert
Short circuit protected	Yes
Polarity protected	Yes
Current consumption	60 mA at 24 Vdc (Max. 80 mA)
Output load	± 40 mA
Output frequency max	200 kHz
Cable length max	100 m at 100 kHz (Fiber length max 2700 m)
Channel separation	90° el ± 25° el
Dividing error	±50° el
Overvoltage protection	Available upon request

## Encoder configuration

Type	XHI
Model	803 Standard
Shaft type	Ø16 mm blind hollow shaft
Flange type	86-flange
Resolution	1024
Power supply	9-30 Vdc
Output signal	HTL
Connection type	M23 connector 12-pin + Optolink
Connecting direction	Radial
Torque support	120 degrees torque bracket
Pin layout	CW
Number of channels	6
Advanced Diagnostic System	Available upon request

## Dimensions

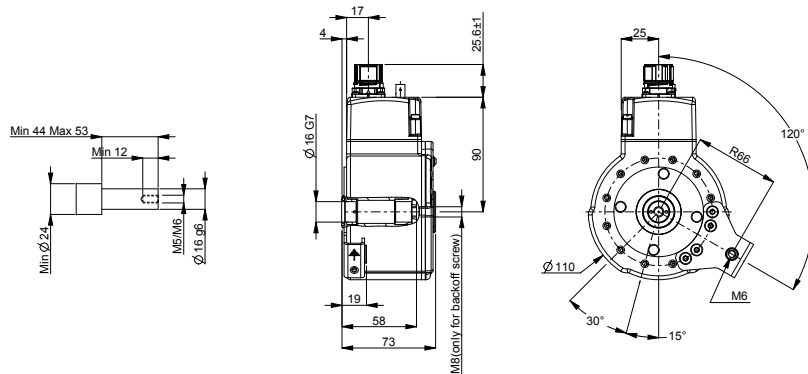

## Output signals



## Pin configuration

Function	Pin
S00	5
S00 inverted	6
S90	8
S90 inverted	1
Sref	3
Sref inverted	4
+E Volt	12
0 Volt	10
Status	7
Shield	Case
ST connector	
Optolink	Fiber

## Ordering information

Part number 809780-01