



- Robust encoder in compact design
- Total build length 55 mm
- Through-going hollow shaft with insulated peek insert



Technical data

Operating temperature	-40 °C .. +100 °C
Ingress protection class [IEC 60529]	IP67 (IP66 at shaft inlet)
Vibration [IEC 60068-2-6]	≤ 200 m/s ²
Shock [IEC 60068-2-27]	≤ 1500 m/s ²
Cover material	Aluminium (anodized)
Weight	1000 g
Shaft load (axial/radial)	50 N / 100 N
Rotational speed max	6000 rpm
Shaft material	Stainless steel with insulated peek insert
Short circuit protected	Yes
Polarity protected	Yes
Current consumption	60 mA at 24 Vdc (Max. 80 mA)
Output load	± 40 mA
Output frequency max	200 kHz
Cable length max	100 m at 100 kHz
Channel separation	90° el ± 25° el
Dividing error	±50° el

Encoder configuration

Type	CHI
Model	703
Shaft type	Ø1 inch through-going hollow shaft
Flange type	87-flange
Resolution	3072
Power supply	5-30 Vdc
Output signal	HTL
Connection type	M23 connector 12-pin
Connecting direction	Radial
Pin layout	CCW
Torque support	Tether arm with insulated peek insert

Dimensions

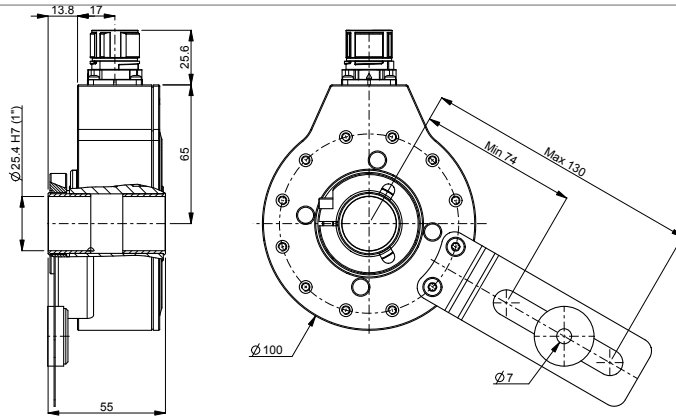

Output signals



Pin configuration

Function	Pin
S90 inverted	1
Not used	2
Sref	3
Sref inverted	4
S00	5
S00 inverted	6
Status	7
S90	8
Not used	9
0V	10
Not used	11
+EV	12

Ordering information

Part number 809760-01