



- Performance hollow shaft encoder for heavy duty industries
- High vibration and shock resistance
- Electrically insulated shaft



Technical data

Operating temperature	-20 °C .. +85 °C
Ingress protection class [IEC 60529]	IP67 (IP66 at shaft inlet)
Vibration [IEC 60068-2-6]	≤ 200 m/s ²
Shock [IEC 60068-2-27]	≤ 1500 m/s ²
Cover material	Aluminium (anodized)
Weight	1400 g
Shaft load (axial/radial)	100 N / 300 N
Rotational speed max	6000 rpm
Shaft material	Stainless steel with insulated peek insert
Short circuit protected	Yes
Polarity protected	Yes
Output load	± 40 mA
Output frequency max	200 kHz
Cable length max	350 m at 100 kHz
Channel separation	90° el ± 25° el
Dividing error	±50° el
Overvoltage protection	Available upon request

Encoder configuration

Type	XHI
Model	803 Standard
Shaft type	Ø16 mm blind hollow shaft
Flange type	86-flange
Resolution	2048
Power supply	9-30 Vdc
Output signal	HC-HTL
Connection type	M23 connector 12-pin + ADS Online
Connecting direction	Radial
Torque support	120 degrees torque bracket
Pin layout	CW
Number of channels	6
Advanced Diagnostic System	ADS Online

Dimensions

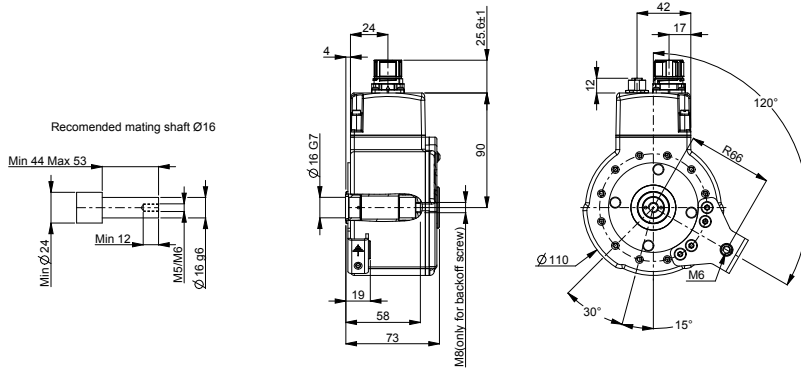

Output signals



Pin configuration

Function	Pin
+E Volt	12
0 Volt	10
Sref	3
Sref inverted	4
S90	8
S90 inverted	1
S00	5
S00 inverted	6
Status green +	7
Status green -	2
Status red +	9
Status red -	11
M12 connector (Ethernet)	
Tx +	1
Rx +	2
Tx -	3
Rx -	4

Ordering information

Part number 809674-02