

- 58mm diameter
- Extremely robust design
- Shock and vibration protected
- Inductive scanning



Technical data

Operating temperature	-40 °C .. +70 °C
Ingress protection class [IEC 60529]	IP67
Current consumption	95 mA at 24 Vdc
Vibration [IEC 60068-2-6]	≤ 300 m/s ²
Shock [IEC 60068-2-27]	≤ 2000 m/s ²
Cover material	Aluminium (anodized)
Weight	430 g
Shaft load (axial/radial)	100 / 125 N
Shaft material	Stainless steel
Rotational speed max	12000 rpm
Polarity protected	Yes

Encoder configuration

Type	ISA
Model	608 Multiturn
Shaft type	Ø10 mm round
Flange type	Clamping flange (61sp-type)
Resolution	25 bit (13 bit singleturn + 12 bit multiturn)
Power supply	9-36 Vdc
Output signal	PROFIBUS DP
Connection type	Cable gland
Connecting direction	Radial

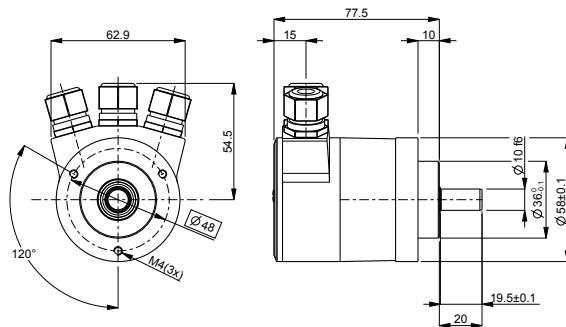
Dimensions**Output signals****Pin configuration**

Function	Terminal
+E Volt	+
0 Volt	-
B** (Bus in)	B
A* (Bus in)	A
B** (Bus out)	B
A* (Bus out)	A

*A terminals are connected
**B terminals are connected

Ordering information

Part number

809645-01