

- 58mm diameter
- Single turn resolution  $\leq 10$  bit
- Robust design
- Shock and vibration protected



## Technical data

Operating temperature	-40 °C .. +80 °C
Ingress protection class [IEC 60529]	IP67/IP66 (Encoder body/Shaft inlet)
Current consumption	40 mA at 24 Vdc
Vibration [IEC 60068-2-6]	$\leq 300$ m/s <sup>2</sup>
Shock [IEC 60068-2-27]	$\leq 2000$ m/s <sup>2</sup>
Cover material	Aluminium
Weight	300 g
Shaft load (axial/radial)	10 N / 20 N
Shaft material	Stainless steel
Rotational speed max	6000 rpm
Polarity protected	Yes

## Encoder configuration

Type	RHA
Model	506 Singleturn
Shaft type	Ø12 mm blind hollow shaft
Flange type	56/57-flange
Resolution	10 bit singleturn
Power supply	9-36 Vdc
Output signal	Analogue 4-20 mA
Connection type	Cable
Connecting direction	Radial
Cable length	1.50 m
Active angle	120.0

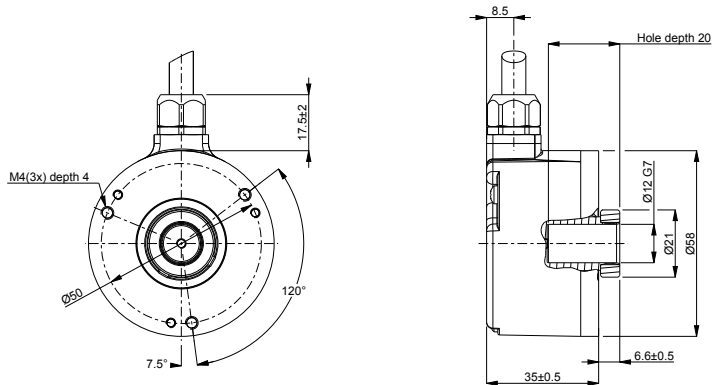
**Dimensions****Output signals****Pin configuration**

Function	Colour
+E V	Red
0 Volt	Blue
I out	Green
Preset	White
Code sequence	Black
Chassis	Shield

**Ordering information**

Part number

770591-04