

- Performance hollow shaft encoder for heavy duty industries
- High vibration and shock resistance
- Electrically insulated shaft



Technical data

Operating temperature	-20 °C .. +85 °C
Ingress protection class [IEC 60529]	IP67 (IP66 at shaft inlet)
Vibration [IEC 60068-2-6]	≤ 200 m/s ²
Shock [IEC 60068-2-27]	≤ 1500 m/s ²
Cover material	Aluminium (coated)
Weight	1300 g
Shaft load (axial/radial)	100 N / 300 N
Rotational speed max	6000 rpm
Shaft material	Stainless steel with insulated peek insert
Short circuit protected	Yes
Polarity protected	Yes
Current consumption	60 mA at 24 Vdc (Max. 80 mA)
Output load	± 40 mA
Output frequency max	200 kHz
Cable length max	350 m at 100 kHz
Channel separation	90° el ± 25° el
Dividing error	±50° el

Encoder configuration

Code key description	861117256
Type	XHI
Model	861
Shaft type	Ø12 mm blind hollow shaft
Flange type	86-flange
Resolution	1024
Power supply	9-30 Vdc
Output signal	HC-HTL
Connection type	M23 connector 12-pin
Connecting direction	Radial
Pin layout	CCW
Number of channels	6
Advanced Diagnostic System	ADS Classic
Torque bracket	120 degrees orientation

Dimensions

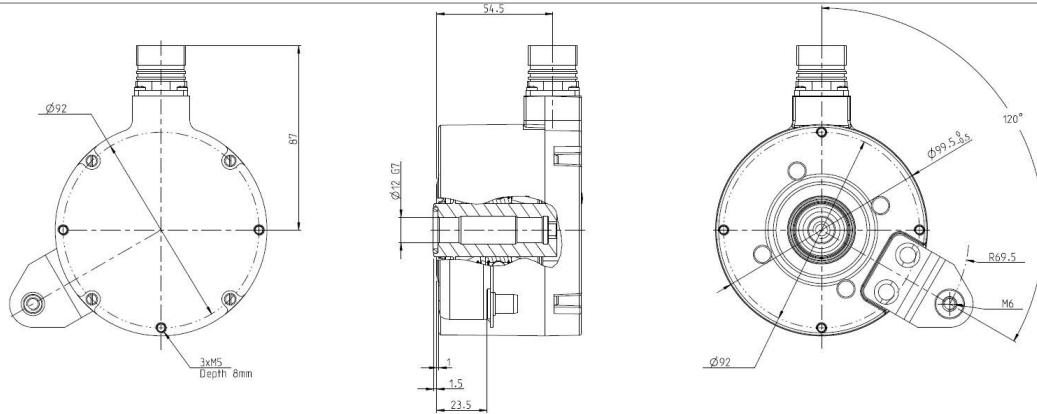

Output signals



Pin configuration

Function	Pin
+E Volt	12
0 Volt	10
2 (S00)	5
2 inverted (S00\)	6
1 (S90)	8
1 inverted (S90)	1
0 (Sref)	3
0 inverted (Sref\)	4
Alarm +	9
Alarm -	11
RXD	7
TXD	2

Ordering information

Part number

752893-01